

CARSON

2021/2022



***Wir bewegen was!
We make a difference.***

SIMBA · DICKIE · GROUP



UNSERE ZENTRALVERWALTUNG IN FÜRTH/BAYERN

Hier entwickeln und planen wir unser Sortiment für Sie.

OUR CENTRAL ADMINISTRATION IS SITUATED IN FUERTH/ BAVARIA

Here we develop and plan our product range for you.



UNSER LOGISTIKZENTRUM UND UNSERE HAUSEIGENE RENN- UND TESTSTRECKE

Hier in Sonneberg/Thüringen wird unsere Ware gelagert und verschickt. Auf unserem Raceway werden unsere Modelle ausgiebig getestet und die Finalveranstaltungen unserer beiden Rennserien durchgeführt.

OUR LOGISTICS CENTRE AND OUR IN-HOUSE RACE- AND TESTING TRACK

In Sonneberg/Germany we store and dispatch our products. We use our raceway for the thorough testing of our models and for holding the two final events of our two racing series.

TAMIYA-CARSON Modellbau GmbH & Co. KG

TAMIYA-CARSON, Mitglied der SIMBA DICKIE GROUP, ist einer der führenden Modellbauanbieter, der Modellbaufachhändler in Deutschland und Europa beliefert. Anspruchsvolle RC-Modelle stellen unser Kernsortiment dar. Die Eigenmarke CARSON wird europaweit vertrieben.

CARSON

CARSON ist Spezialist für RC-High Tech Modelle und bietet ein ausgesuchtes und umfangreiches Zubehörsortiment für den RC-Sport in zahlreichen Maßstäben an. Um die Qualität unserer Produkte zu erhöhen und auf diesen Topniveau zu halten, haben wir bei CARSON, in eigene Werkzeugformen und eigenen Ingenieuren (vor Ort) investiert. Zwar sind eigene Formen teurer, aber nur so können wir unser hochwertiges Qualitätsniveau bieten und halten. Der voll funktionsfähige Linde Gabelstapler zum Beispiel, ist eine innovative Eigenentwicklung für den europäischen Markt, die ebenfalls komplett mit eigenem Werkzeug produziert wird.

KUNDENNÄHE

Wir präsentieren unser Sortiment auf zahlreichen Modellbaumessen in ganz Deutschland und Österreich. Hier wird der Kontakt mit Kunden und Fans gepflegt, Neuheiten präsentiert und gefachsimpelt. Besuchen auch Sie uns auf einer der nächsten Messen.

Informationen und Termine finden Sie unter www.carson-modelsport.com

TAMIYA-CARSON, member of the SIMBA DICKIE GROUP, is a leading model build supplier which is supplying the model specialist dealers in Germany and Europe. Demanding RC models represent our core range. The in-house brand CARSON is marketed throughout Europe.

CARSON

CARSON is a specialist for RC high tech models and offers a selected and large assortment of accessories for the RC sports in several scales. To advance the quality of our products and keep it on a top level, we invest in own toolrooms and engineers. In fact own shapes are expensive, our top level quality is keeping. For example the fully functional Linde Gabelstapler is an innovative in-house development for the European market and is also produced completely with own tools.

PROXIMITY TO CUSTOMERS

We participate our assortment on several model making exhibitions through out Germany and Austria. Here we stay in touch, participate novelties and talk shop. Visit us on one of our next exhibitions.

More information and dates you can find here www.carson-modelsport.com

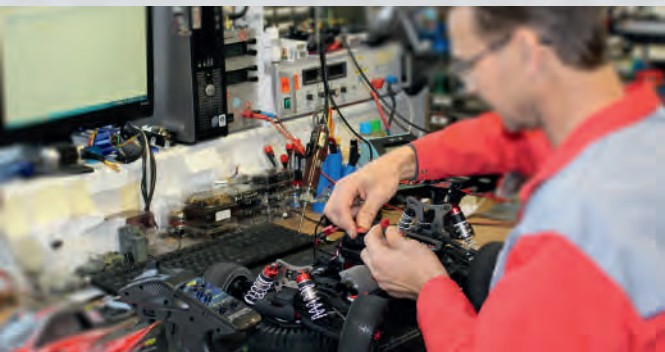

UNSER SERVICE

Modellbaueinsteiger und Profis sind mit Ihren CARSON Modellen bei unserem Service-Team bestens aufgehoben.

OUR SERVICE

Our professional service department will support all beginners or professionals and find always the best solution for you.



UNSER BÜRO IN HONG KONG

Hier haben wir ein Einkaufs- und Entwicklungsteam, das den Markt scannt und für uns neue Produkte entwickelt.

OUR OFFICE IN HONG KONG

Here we maintain a purchasing and development team for market scanning and product development.

Informationen / Informations

100% RTR / RTF: RTR steht für „Ready To Run“, das bedeutet das diese Modelle komplett montiert und mit Batterien, Akku und Ladegerät versehen sind und nach dem einlegen der Batterien bzw. aufladen des Akkus umgehend zum Einsatz bereit sind.

MHz: Bei Fernsteuerungen mit MHz-Technik werden die Steuerbefehle mit Hilfe von Funksignalen, die in genau festgelegten Frequenzbereichen schwingen, gesendet. Jedes Modell mit MHz-Steuerung benötigt daher eine bestimmte Frequenz bzw. einen eigenen Kanal. Um mindestens zwei Modelle gleichzeitig betreiben zu können gibt es 27 MHz und 40 MHz Fernsteuerungen, diese sind je nach Ausführung noch mit einem ABC-Wahlschalter versehen, das heißt im besten Fall können 6 MHz Modelle gleichzeitig betrieben werden ohne sich zu stören.

2.4 GHz: 2.4 GHz steht für die Hochfrequenzbänder, die lizenzfrei von Industrie, Wissenschaft und Medizin genutzt werden dürfen. Der 2.4 GHz-Sender sendet Informationen in codierter Form und der Empfänger muss diesen entschlüsseln. 2.4 GHz-Sender und Empfänger sind daher aufeinander abgestimmt und werden auch schon von uns so ausgeliefert. Der große Vorteil der 2.4 GHz-Technologie liegt in der Vielzahl von Modellen, die problemlos gleichzeitig betrieben werden können, da sie automatisch auf freie Kanäle ausweichen.

100% RTR / RTF: RTR stands for "Ready To Run", meaning that these models come fully assembled, and supplied with batteries, battery pack and charger. Once the batteries have been put in or the battery pack charged, they are ready to use.

MHz: In the case of remote control systems based on MHz technology, commands are relayed by means of radio signals transmitted at specific frequencies. Every model with MHz control therefore requires a particular frequency or its own channel. To be able to operate at least two models at the same time, there are 27 MHz and 40 MHz remote control systems. Depending on the design, these also have an ABC selector switch, so at best, six MHz models can be operated at the same time with no interference problems.

2.4 GHz: 2.4 GHz stands for license-free high-frequency bands whose use is permitted for industry, science and medicine. Information is sent in encoded form by the 2.4 GHz transmitter and the receiver has to decode it. The 2.4 GHz transmitter and receiver are therefore a matched pair and are also supplied by us in this form. The major advantage of the 2.4 GHz technology lies in the multitude of models that can be operated trouble-free simultaneously, since they automatically divert to free channels.



Carson Modelsport

Besuchen Sie uns auf Facebook / Visit us on facebook



www.youtube.com/carsonmodelsport



www.twitter.com/dickietamiya

TAMIYA-CARSON Modellbau GmbH & Co. KG
Werkstraße 1 · DE-90765 Fürth/Germany

www.carson-modelsport.com



Piktogramme / Symbols



Altersfreigabe
Age rating



2WD mit angetriebener
Hinterachse / 2WD Rear
Wheel Drive (RWD)



2WD mit angetriebener
Vorderachse / 2WD Front
Wheel Drive (FWD)



4WD mit angetriebener
Vorder-Hinterachse /
4WD All Wheel Drive



2WD mit angetriebener
Hinterachse / 2WD Rear
Wheel Drive (RWD/6x2)



2WD mit angetriebener
Vorderachse / 2WD Front
Wheel Drive (FWD/6x2)



4WD mit angetriebener
Hinterachse / 4WD All
Wheel Drive (6x4)



6WD mit angetriebener
Vorder-Hinterachse /
6WD All Wheel Drive (6x6)



Raupen - Kettenantrieb
Chain drive



Volle Fahrfunktionen
Full Driving Function



Voll proportional
steuerbare Fahrfunktion
Full Proportional Function



Kanal-Angabe
Channels



Kanal-Angabe + Licht
Channels + Light



Kanal-Angabe + Tür
Channels + Door



Kugelgelagerte
Komponenten
Ball raced components



Voll gefedert
Full suspension



Spritzwassergeschützt
Splashproof

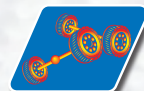

Extern verschränkbare
Pendelachse / Externally
interlockable swing axle



Differenzialgetriebe
Differential gear



Radmitnehmer
Drive Washer



Sicherheitsabschaltung
Safety Cutoff



Fährt im Wasser
Drives in the Water



Maßstab
Scale



Geschwindigkeit Km/h
Speed Km/h



Gewicht
Weight



Brushed Motor
Brushed Motor



Brushless Motor
Brushless Motor



Nitro Motor
Nitro Engine



Benzin Motor
Petrol/Gas-Power Engine



Zwei Motoren
Twin Motors



2,4 GHz
2.4 GHz



5,8 GHz
5.8 GHz



27 MHz
27 MHz



40 MHz
40 MHz



Infrarot
Infrarot



WiFi Netzwerk
WiFi Network



WiFi Übertragung an
Tablet/Handy / WiFi Connection
to Tablet/Mobile Phone



Reichweite
Range



Fahrzeit / Flugzeit
Driving Time / Fly Time



Ladezeit
Charging Time



In-Outdoor
In-Outdoor



Indoor
Indoor



Outdoor
Outdoor



Fahrakku NickelMetallhydrid
Racing Pack NiMH



Fahrakku Lithium Polymer
Racing Pack LiPo



Fahrakku Lithium Ionen
Racing Pack Lilon



Akkukapazität
Rech. Battery Capacity



Senderbatterien Micro
AAA/LR03 / Transmitter
Batteries Micro AAA/LR03



Senderbatterien Mignon
AA/R6 / Transmitter
Batteries Mignon AA/R6



Senderbatterien
9V Block/6F22 / Transmitter
Batteries 9V Block/6F22



Steckerladegerät
Plug Charger



USB-Ladegerät
USB-Charger



Ladefunktion über Sender
Transmitter w/Charging
Function



Beleuchtung
Light Unit



LED Beleuchtung
LED Light Unit



Martinshorn + Blaulicht
Sirene Sound + Light



Sound



Motorensound
Engine Sound



Hupe
Horn



Wasserspritzfunktion
Water spray function



Sound/Musik
Sound/Music



Schließfunktion
Lock Function



Kamera/Fotofunktion
Camera/Photo Function



Kamera/Videofunktion
Camera/Video Function



Kamera/Videofunktion
Auflösung 480P / Camera
Video Function Resolution 480P



Kamera/Videofunktion
Auflösung HD 720P / Camera
Video Function Resolution HD 720P



Gyro / Flugstabilisierung
Gyro / Flight Stabilizer



Gyro / Flugstabilisierung
6-Achsen / 6 - Axle Gyro
Flight Stabilizer



Headless
Headless



3D Flugmodus
3D Flightmode



Looping/Stuntmodus
Looping/Stuntmode



HOVER Mode
HOVER Mode



Coming Home
Coming Home



Wählbare
Geschwindigkeitsstufen
Speed Adjustable



Boost/Powermodus
Boost/Powermode



Aufrichtautomatik
Straighten Up function



Ergonomisch einstellbar
ergonomic adjustable



Empfänger enthalten
Contains receiver



4 Kanal Empfänger
4-Channel Receiver



Mit Servo / Stellkraft
With Servo / Torque



LCD Display
LCD Display



Länge
Length



Durchmesser Rotorblätter
Diameter rotor blades



Spannweite
Wingspan



Neuheit
News



10



87



26

BRUSHED / BRUSHLESS

NITRO



68



93

PANZER / TANK

TRUCK MULTIFUNCTION



100

Inhalt / Contents

10 **1:87-LINE**26 **FE-LINE**32 **X10-LINE 2WD**36 **X10-LINE 4WD**44 **OFF-ROAD-LINE**44 **FY-LINE**53 **CY-LINE BRUSHLESS**58 **VIRUS-LINE BRUSHLESS**68 **CV-LINE NITRO**75 **CY-LINE NITRO**80 **VIRUS-LINE NITRO**86 **GP**



106

BOOTE / BOATS

ELEKTRONIK / ELECTRONICS

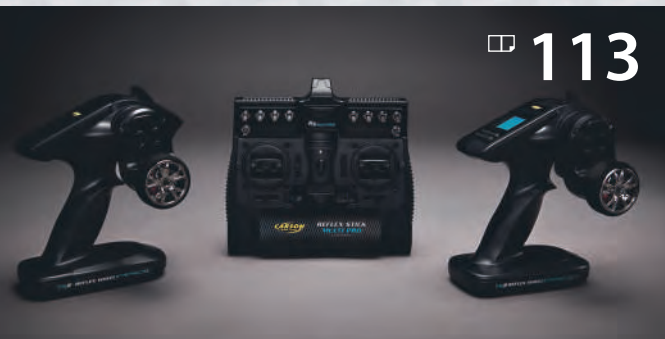

113



138

ANTRIEBSTECHNIK / DRIVE TECH.



140

LADETECHNIK / CHARGING TECH.



133

REIFENSÄTZE / WHEEL SETS



160

CARSON FOR TAMIYA

ZUBEHÖR / ACCESSORIES



169

- 87 PREMIUM-LINE
- 93 PANZER / TANK
- 98 TRUCK MULTIFUNCTION
- 106 BOOTE / BOATS
- 113 REFLEX WHEEL-LINE
- 121 REFLEX STICK-LINE

- 129 SERVOS
- 130 RC LED-EINHEITEN / UNITS
- 133 ANTRIEBSTECHNIK / DRIVE TECH.
- 137 VERBRENNER / NITRO
- 140 LADETECHNIK / CHARGING TECH.
- 153 REIFENSÄTZE / WHEEL SETS

- 160 CARSON FOR TAMIYA
- 169 ZUBEHÖR / ACCESSORIES
- 173 TASCHEN / BAGS
- 174 KAROSSERIEN / BODIES



THE NEW RC-SPORT LINE



CARSON
RC-SPORT-Katalog
2021 (DE/ENG)
N° 500990266

CARSON RC-SPORT

CARSON ist der Spezialist für RC-High Tech Modelle und bietet ein ausgesuchtes und umfangreiches Zubehörsortiment für den Modellsport in zahlreichen Maßstäben an. Um die Qualität unserer Produkte zu erhöhen und auf diesen Topniveau zu halten, haben wir bei CARSON in eigene Werkzeugformen und eigenen Ingenieuren (vor Ort) investiert. Nun haben wir unser Sortiment um die RC-Sport Serie erweitert, die Neueinsteigern einen günstigen Einstieg in das RC-Hobby ermöglichen soll, ohne dabei auf Qualität verzichten zu müssen.

CARSON RC-SPORT

CARSON is the specialist for high-tech RC models and offers a well-selected, comprehensive range of Modellsport accessories in different sizes to scale. In order to improve the quality of our products and maintain this top level, we at CARSON have invested in our own tool forms and on-site engineers. Now we have extended our product range to include the RC-sport series which is targeted at enabling newcomers an affordable entry to the RC hobby, without compromising on quality.

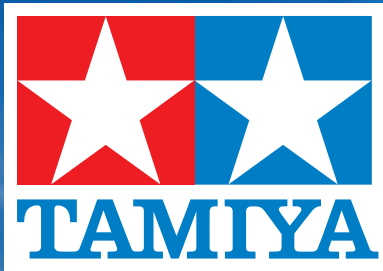

TOY FAIR 2020 NEWS



MESSENEUHEITEN

2021 (DE/ENG)
N° 500990143

GEBALLTE NEUHEITENSHOW!

TAMIYA-CARSON hat in dem aktuellen Werk der Messeneuheiten 2021 zusammengefasst, was zur Spielwarenmesse 2021 der Öffentlichkeit präsentiert worden ist. Das starke Sortiment der erfolgreichen Vertriebsmarken umfasst vom LKW RC-Modellbaukasten über das Highspeed Brushlessmodell, bis hin zum Flugzeug aus dem Bausatzkasten alles, was das Modellbauherz höher schlagen lässt. So sind auch die neuesten Slot-Rennbahnen und Fahrzeuge darin enthalten, die für Rennsportfeeling in den eigenen 4 Wänden sorgen.

New products!

TAMIYA-CARSON has summed up the new products which were presented to the public at the 2021 toy fair in their current trade fair product news 2021 edition. The strong range of successful sales brands comprises everything that makes the heart of the model builder beat faster, from the HGV RC model kit, to the high-speed brushless model or the model kit aeroplane. It also includes the latest slot car racetracks and models which provide indoor racing sport fun at home. Get your trade fair product news 2021!



WEITERE INSPIRATION

TAMIYA RC-Katalog
2021/22 (DE/ENG)
N° 500992020

Unsere Modelle in Aktion und weitere Informationen
finden Sie unter www.tamiya.de

More Information about the Models: www.tamiya.de

**NEU
NEW**



1:87-Line



1:87 VW T1 BUS KASTENWAGEN

12



1:87 VW T1 BUS ADAC

13



1:87 VW T1 BUS POLIZEI

21



1:87 MERCEDES-BENZ UNIMOG U406 THW

18



1:87 VW T1 BUS FEUERWEHR

16



1:87 VW T1 BUS MIT ANHÄNGER

17



1:87 MERCEDES-BENZ UNIMOG U406 FEUERWEHR

19



1:87 VW T1 BUS SINALCO

14



1:87 VW T1 BUS PRITSCHKE KOMMUNAL

20



1:87 MERCEDES-BENZ UNIMOG U406 CAMOUFLAGE

23



1:87 MERCEDES-BENZ UNIMOG U406 FORST

22



1:87 MERCEDES-BENZ UNIMOG U406 MIT ANHÄNGER

25



1:87 VW T1 BUS DUNLOP MIT ANHÄNGER

15



1:87 MERCEDES-BENZ UNIMOG U406 KOMMUNAL

24



1:87 LINIE - HIGH-TECH IM KLEINSTFORMAT

Die Entwickler von CARSON haben all Ihre Erfahrung in die Entwicklung der neuen 1/87 Linie einfließen lassen. So verfügen die Kultwagen im Maßstab H0 über eine störungsfreie 2,4 GHz Fernsteueranlage, die eine fein abgestimmte Steuerung (digital-proportional) von Gas und Lenkung mit Lenkungstrimmung zulässt. Der eingebaute Li-Ion Fahrakku ermöglicht eine Fahrzeit von bis zu 35 Minuten bei nur 30 Minuten Ladezeit und wird über den Power-Plug direkt am Sender geladen. Damit sind die kleinen Fahrzeuge auch unterwegs immer fahrbereit. Durch ihren sehr kleinen Wendekreis fühlen sich die Nostalgiker alternativ zum Schreibtisch auch auf einer Eisenbahnanlage wohl und bringen somit auch neben den Gleisen Bewegung auf die Straße. Die detaillierte Lackierung und Bedruckung, sowie funktionierende Fahr- und Rückleuchten runden den starken Auftritt der kleinen Klassiker ab und die technisch designte Fernsteuerung „Reflex Stick Micro“ bildet perfekt das Bindeglied zwischen Nostalgie und Moderne. Aufbewahrt werden Fahrzeug und Sender in einer mitgelieferten Vitrine. 4 AAA Senderbatterien vervollständigen den Lieferumfang zu einem 100 % Komplett-Set. Viel Spaß mit der neuen 1/87 Linie von CARSON.

1:87 LINE - HIGH-TECH IN THE SMALLEST FORMAT

The development team at CARSON have channelled all their experience into the development of the new 1:87 Scale Line. The cult vehicles in a scale of H0 are equipped with an interference-free 2.4 GHz remote control system, which allows a finely tuned control (digital proportional) of speed and steering with steering trim. The integrated Li-Ion drive battery provides a driving time of up to 35 minutes after only 30 minutes charging time and is charged via the power plug directly on the transmitter. This means that the tiny vehicles are ready for a drive even when you're out and about. This nostalgic vehicles have a very small turning circle and are therefore just as much at home on a model railway layout as it is on a desk, bringing movement onto the roads around the railway tracks. The detailed paintwork and decoration, along with the functioning headlights and rear lights, provide the perfect finishing touches to the striking appearance of this little classics and the technically designed remote control "Reflex Stick Micro" provides the ideal link between nostalgia and the latest technology. The vehicle and transmitter are stored in the case supplied. 4 AAA transmitter batteries are also supplied to make this a 100 % complete set. Have lots of fun with the new 1:87 Line from CARSON.

Und der Gewinner ist ... / And the winner is ...



CARSON STELLT DEN DIE SJÄHRIGEN INNOVATIVEN TOY AWARD GEWINNER 2018.

Die Jury kürte den RC-gesteuerten VW-Bully T1 Samba von TAMIYA-CARSON Modellbau zum Gewinner der Kategorie Teenager & Adults. So standen 642 Mitbewerber (in allen Kategorien) dem kleinen Nostalgiker im Maßstab H0 aus dem Hause CARSON gegenüber.

Der Preisträger bringt seine Brüder in Form des VW T1 Kastenwagen und VW T1 Pritsche-Plane mit in den Handel.

Viel Spaß mit Deiner 1:87 Linie von CARSON!

CARSON DELIVERS THIS YEAR'S TOY AWARD 2018 WINNER.

The jury declared the RC-controlled VW-Bully T1 Samba by TAMIYA-CARSON Modellbau the winner in the Teenager & Adults category. The little vintage model from CARSON competed against 642 participants (from all categories) in the H0 category.

The winner will be accompanied commercially by its relatives in the form of the VW T1 panel van and the VW T1 flatbed lorry.

Have fun with your 1:87 line from CARSON!



N° 500504119
1:87 VW T1 Samba Bus 2.4 GHz 100% RTR



BRUSHED / BRUSHLESS

N° 500504136
1:87 VW T1 Bus Samba ADAC 2.4 GHz 100% RTR



N° 500504133

1:87 VW T1 Bus Kastenwagen Sinalco 2.4 GHz 100% RTR

8+ 4x AAA 1:87

2.4 GHz 50 m STOPP 35 min

30 min Lilon 2WD 50 mm

NEU NEW



N° 500504135

1:87 VW T1 Bus Dunlop mit Anhänger 2.4 GHz 100% RTR



N° 500504120

1:87 VW T1 Bus Kastenwagen Feuerwehr 2.4 GHz 100% RTR



BRUSHED / BRUSHLESS

N° 500504122
1:87 VW T1 Bus Samba mit Anhänger 2.4 GHz 100% RTR



N° 500504138

1:87 Mercedes-Benz Unimog U406 THW 2.4 GHz 100% RTR

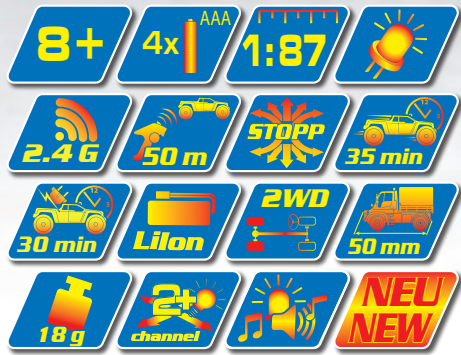

BRUSHED / BRUSHLESS

N° 500504139

1:87 Mercedes-Benz Unimog U406 Feuerwehr 2.4 GHz 100% RTR

8+ 4x AAA 1:87

2.4 GHz 50 m STOPP 35 min

30 min Lilon 2WD 50 mm

NEU NEW



N° 500504141

1:87 VW T1 Bus Pritsche Kommunal 2.4 GHz 100% RTR



N° 500504121

1:87 VW T1 Bus Kastenwagen Polizei 2.4 GHz 100% RTR



N° 500504126

1:87 Mercedes-Benz Unimog U406 Forst 2.4 GHz 100% RTR



BRUSHED / BRUSHLESS

N° 500504127

1:87 Mercedes-Benz Unimog U406 Camouflage 2.4 GHz 100% RTR



N° 500504125

1:87 Mercedes-Benz Unimog U406 Kommunal 2.4 GHz 100% RTR



BRUSHED / BRUSHLESS

N° 500504140

1:87 Mercedes-Benz Unimog U406 Kommunal mit Anhänger 2.4 GHz 100% RTR



CAGE DEVIL FE
 27



VW BEETLE FE
 30



CAGE DEVIL FE 2.0
 28



THE BLASTER FE
 29



MEGA DUSTER FE
 31

FAST-ENTRY – DER EINSTIEG IN DIE ON-OFFROAD MODELLSPORTWELT

Die FE-Line besteht aus Fahrzeugen die leicht zu bedienen und steuern sind und trotzdem genug Power haben um einen spielerischen Einstieg in die RC-Welt zu bieten. Die Modelle sehen nicht nur cool aus, sondern sind auch schnell und komplett ausgestattet. Ein High Power Li-Ion- oder Li-Po Fahrakku mit Schnell-Ladegerät sorgt für lang anhaltenden Fahrspaß. Die Fahrzeuge sind gefedert und fetzen mit bis 35 km/h durchs Gelände oder über den Asphalt. Die störungsfreie 2,4 GHz Fernsteuerung hat keine sichtbare Antenne und es können mehrere Fahrzeuge gleichzeitig gefahren werden. Dank dem 100% Komplett-Lieferumfang sind die CARSON FE-Line Fahrzeuge sofort startbereit. Kaufen, laden – fahren!

FAST ENTRY – ENTRY INTO THE ON AND OFF ROAD MODEL SPORT

The FE line consists of models that are easy to operate and control but nevertheless have enough power to offer playful entry into the world of RC models. The models not only look cool but are also fast and fully equipped. A high power Li-Ion or LiPo driving battery with a fast charger ensures long-lasting driving fun. The models have sprung suspension and tear across terrain or over the asphalt at up to 35 km/h. The interference-free 2.4 GHz remote control has no visible antennas and several models can be driven simultaneously. Since they come with everything included, the CARSON FE line models are ready to race straight away. Purchase, charge – race!



N° 500404141

1:10 Cage Devil FE 2.4 GHz 100% RTR

A collection of 20 feature icons for the RC car, arranged in five rows. The icons include: 8+ (age), 2WD (drive type), STOPP (stop function), Federung (suspension), 1:10 (scale), 35 km/h (speed), 1.300 g (weight), 2.4 GHz (frequency), 60 m (range), 25 min (runtime), 2,0 h (runtime), house icon (home return), Lilon (battery type), 7.4V (battery voltage), 4x AA (battery type), 1.500 mAh (battery capacity), a lightning bolt icon, a lightbulb icon, a brushed motor icon, 1 um 380 (motor speed), 395 mm (length), and a red 'NEU NEW' badge.



500608199



Ersatzakku / Optional Battery
Li-Ion 7,4V/1500mAh



N° 500404196

1:10 Cage Devil FE 2.0 2.4 GHz 100% RTR



N° 500404144

1:10 The Blaster FE 2.4 GHz 100% RTR



N° 500404142
1:10 VW Beetle FE 2.4 GHz 100% RTR



500608199



Ersatzakku / Optional Battery
Li-Ion 7,4V/1500mAh

N° 500404195

1:10 Mega Duster FE 2.4 GHz 100% RTR

X10-Line 2WD



STREET REBEL
 33



BEETLE WARRIOR
 34

DIE X-10 2 WD LINE BIETET MODELLE MIT AUSGEREIFTER TECHNIK FÜR DEN NÄCHSTEN SCHRITT IN DIE RC-WELT DER MODELLFAHRZEUGE.

Die kraftvollen brushed angetriebenen Hecktriebler haben ausreichend Power um Geschwindigkeiten bis zu 35 km/h zu erreichen. Somit sind weite Sprünge und lange Drifts ein Kinderspiel. Öl-druckstoßdämpfer und lange Federwege bieten genug Reserven um auch im größeren Gelände stets Traktion zu haben. Dank störungsfreiem und voll proportionalen 2.4 GHz RC-System und 100% Komplett-Lieferumfang sind die CARSON X-10 2WDs sofort startbereit. Kaufen, laden - fahren!

THE X-10 2 WD LINE OFFERS MODELS WITH MATURE TECHNOLOGY FOR THE NEXT STEP INTO THE WORLD OF RC MODELS.

These powerful brushed models with rear wheel drive have enough power to reach speeds of up to 35 km/h. As a result, vast jumps and long drifts are child's play. Oil-pressure shock absorbers and long spring excursions offer adequate reserves to ensure traction is always maintained even over rough terrain. Supplied 100% complete including an interference-free, fully proportional 2.4 GHz RC system, the CARSON X-10 2WDs are ready to race straight away. Purchase, charge - race!



- 14+
- 2WD
- STOPP
- 2 Channel
- Federung
- 12 mm
- 1:10
- 35 km/h
- 1.631 g
- 2.4 G
- 150 m
- 12 min
- 2,5 h
- 7.4V
- 4x AA
- Brushed
- 1.700 mAh
- Typ 550
- Lilon
- 420 mm



500608152

Ersatzakku / Additional battery 7.4V / 2200 mAh

N° 500404158
 1:10 X10 Street Rebel 2.4 GHz 100% RTR





N° 500404086
 1:10 X10 Beetle Warrior 2.4 GHz 100% RTR

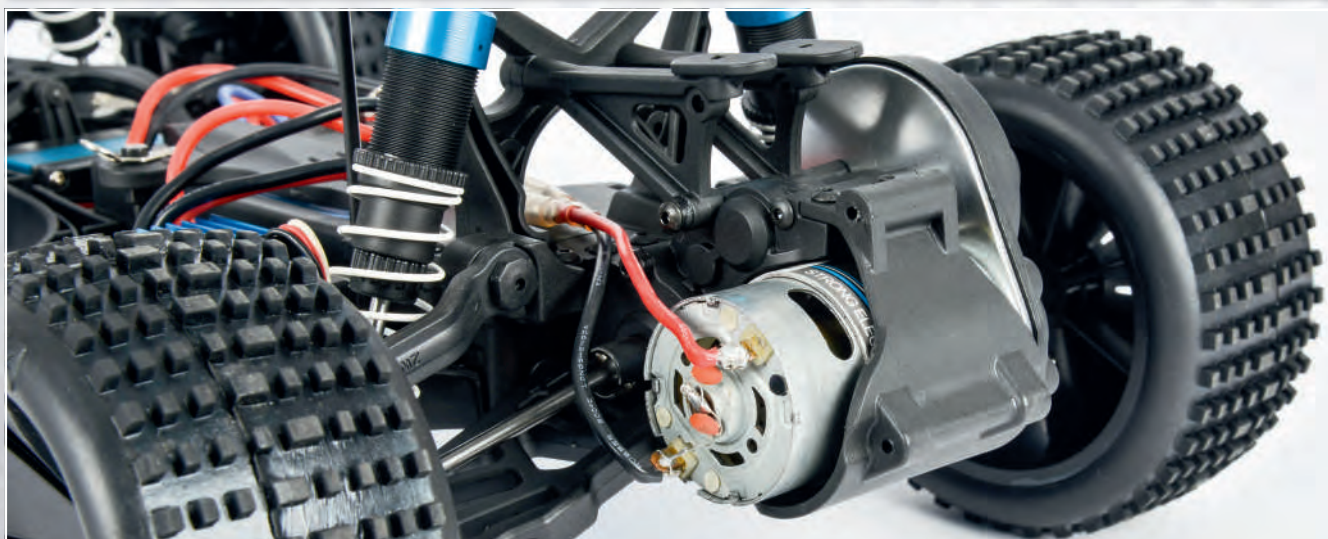
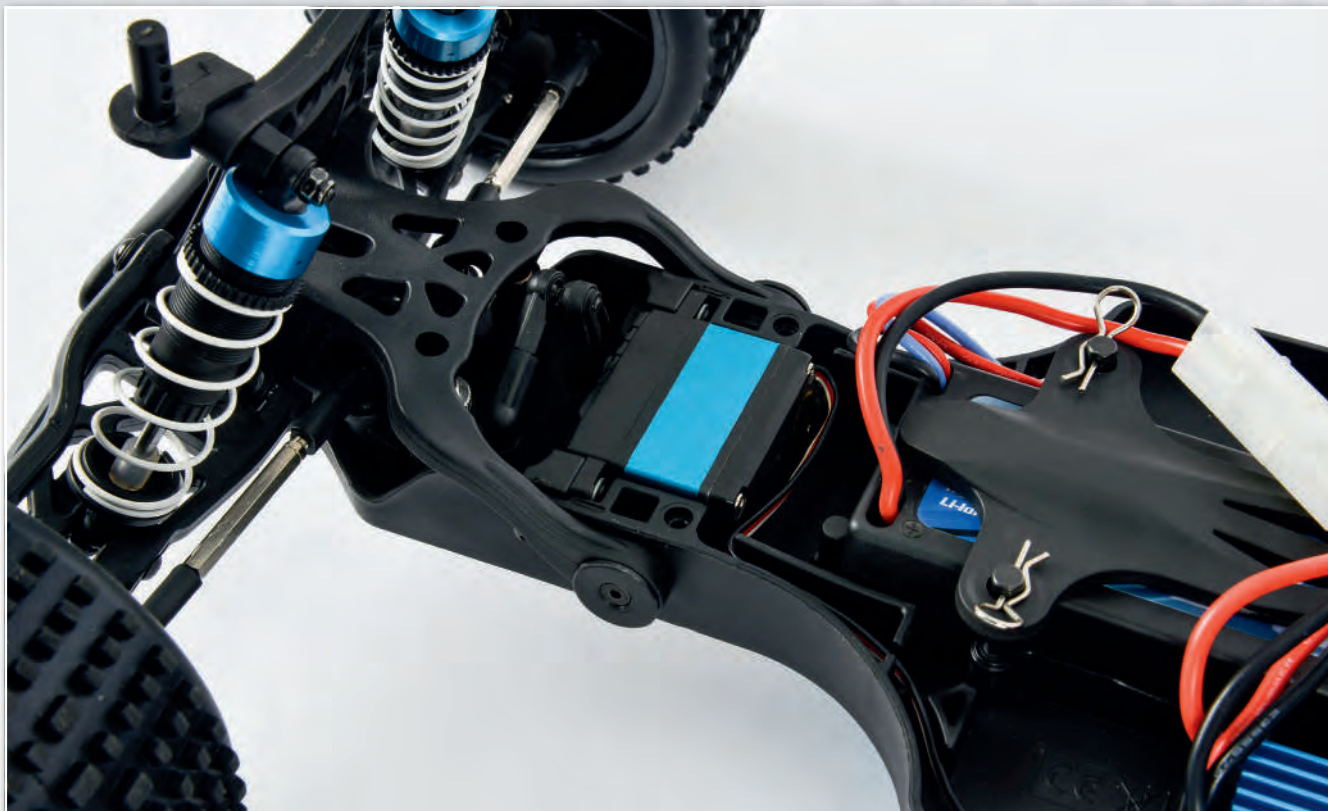

500405668

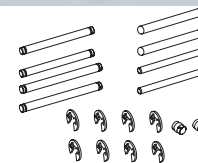

Querlenker- / Achsschenkelstifte v/h
Suspension / c-hub pin f/r

500405669

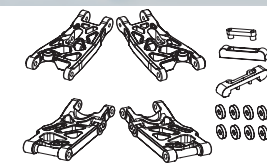

Querlenkerset + Halter v/h unten
Lower Suspensionarmset + holder f/r

500405678



Lenkungseinheit/Servosaver
Steering unit/Servosaver

500900134



All Terrain 2WD Reifen-Set (4)
All Terrain 2WD wheel set (4)

500900137



Reifen-Set Stunt Warrior 2WD
Wheel-Set Stunt Warrior 2WD

500906081



Ladekabel T-Plug
Charging Cable T-Plug

500908162



Corner Marker-Set NEON, Ø 13,5 cm (9 St.)
Corner Marker-Set, Ø 13,5 cm (9 Pc.)

500908133



Transporttasche
Car Bag TAMIYA Fighter

500608152



Li-Ion Akku 7.4V/2200mAh
Li-Ion battery 7.4V/2200mAh

500609042



Mignon-Set NiMH Akkus AA 1,2V (4)
Mignon-Set NiMH rechargeable batteries AA 1,2V (4)

X10-Line 4WD



DIRT WARRIOR SPORT 2.0

37



BAD BUSTER 2.0

39



NINJA

38



CAGE BUSTER

40



MONSTER WARRIOR XL

41

X10 4WD LINE – PROFI TECHNIK FÜR DEN VERSIERTEN MODELLSPORTLER

Die X-10 4WD Line bietet Modelle mit ausgereifter 4-Radantriebstechnik für den nächsten Schritt in die RC-Welt der Modellfahrzeuge. Die kraftvollen brushed angetriebenen Allradfahrzeuge haben ausreichend Power um Geschwindigkeiten bis zu 35 km/h zu erreichen. Somit sind weite Sprünge und lange Drifts ein Kinderspiel. Öldruckstoßdämpfer und lange Federwege bieten genug Reserven um auch im größeren Gelände stets Traktion zu haben. Die OnRoad Versionen haben mittels High-Grip-Reifen genügend Haftung um schnelle Rundenzeiten in den Asphalt zu brennen. Dank störungsfreiem und voll proportionalen 2.4 GHz RC-System und 100% Komplett-Lieferumfang sind die CARSON X-10 4WDs sofort startbereit. Kaufen, laden - fahren!

X10 4WD LINE – PRO TECHNOLOGY FOR EXPERIENCED MODEL SPORT DRIVER

The X-10 4WD line offers models with mature four-wheel drive technology for the next step into the world of RC model vehicles. These powerful brushed models with rear wheel drive have enough power to reach speeds of up to 35 km/h. As a result, vast jumps and long drifts are child's play. Oil-pressure shock absorbers and long spring excursions offer adequate reserves to ensure traction is always maintained even over rough terrain. The high-grip tyres of the on-road versions afford them enough adhesion to burn fast lap times in the asphalt. Supplied 100% complete including an interference-free, fully proportional 2.4 GHz RC system, the CARSON X-10 4WDs are ready to race straight away. Purchase, charge – race!

- 14+
- 4WD
- STOPP
- 2 Channel
- Federung
- 12 mm
- 1:10
- 35 km/h
- 1,420 g
- 2,4 GHz
- 120 m
- 8 min
- 2,0 h
- 7,4V
- 4x AA
- Brushed
- 1,700 mAh
- Typ 540
- Lilon
- 400 mm
- NEU NEW



500608152



Ersatzakku / Optional Battery
Li-Ion 7,4V/2200mAh



N° 500404199

1:10 X10 Dirt Warrior Sport 2.0 2.4 GHz 100% RTR



N° 500404170
1:10 X10 Ninja 2.4 GHz 100% RTR

- 14+
- 4WD
- STOPP
- 2 Channel
- Federung
- 12 mm
- 1:10
- 35 km/h
- 1.933 g
- 2.4 G
- 100 m
- 10 min
- 3,0 h
- Lilon
- 1.700 mAh
- 4x AA
- Brushed
- Typ 550
- 410 mm



500608152

Ersatzakku / Optional Battery
Li-Ion 7,4V/2200mAh



BRUSHED / BRUSHLESS

N° 500402129

1:10 X10 Bad Buster 2.0 2.4 GHz 100% RTR



500608152



Ersatzakku / Optional Battery
Li-Ion 7,4V/2200mAh



N° 500402130

1:10 X10 Cage Buster 2.4 GHz 100% RTR

- 14+
- 4WD
- STOPP
- 2 Channel
- Federung
- 12 mm
- 1:10
- 40 km/h
- 1.420 g
- Brushed Typ 550
- 2.4 G
- 120 m
- 10 min
- 2,0 h
- Lilon
- 7,4V 2.000mAh
- 4x AA
- 405 mm
- NEU NEW



500608152



Ersatzakku / Optional Battery
Li-Ion 7,4V/2200mAh



N° 500404223

1:10 X10 Monster Warrior XL 2.0 2.4 GHz 100% RTR

500405346

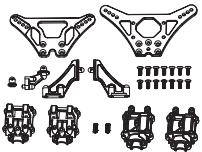

Dämpferbrücke/Getriebegehäuse Set
Shock tower/gear box set

500405350

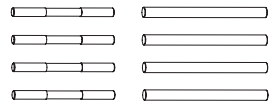

Querlenker- / Achsschenkelstifte v/h
Suspension / c-hub pin f/r

500405351

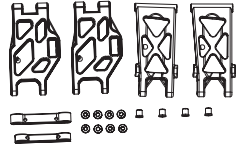

Querlenker Set + Halter v/h
Suspension arm + holder f/r

500405352



2 x Achsschenkel-Set hinten
2 x Rear hub set

500405353

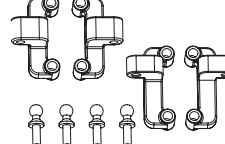

4x Obere Querlenkerhalter v/h
4x Upper turnbuckle holder f/r

500405354

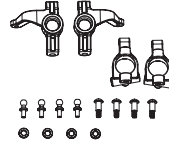

2x Achsschenkel-Set vorne
2x Front hub set

500405567

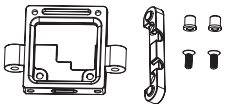

Querlenkerhalter-Set v/h
Suspension armholder set f/l

500405574

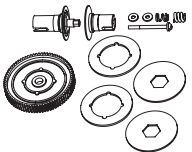

Rutschkupplung-Set + Zahnrad /
Slipper clutch set + gear

500900099

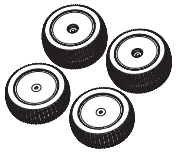

4 x Reifenset
4 x Pre glued tyres

500608152



Li-Ion Akku 7.4V/2200mAh
Li-Ion battery 7.4V/2200mAh

500405750



Frontrammer Set
Front Bumper set

500405752



Hauptzahnrad
Main gear

500609042



Mignon-Set NIMH Akkus AA 1,2V (4)
Mignon-Set NiMH rechargeable batteries AA 1,2V (4)

500900135



Super Gripp 4WD Reifen-Set (4)
Super Gripp 4WD wheel set (4)

500900136



All Terrain 4WD Reifen-Set (4)
All Terrain 4WD wheel set (4)

500908162



Corner Marker-Set NEON, Ø 13,5 cm (9 St.)
Corner Marker-Set, Ø 13,5 cm (9 Pc.)

500908133



Transporttasche
Car Bag TAMIYA Fighter

500503028



Tamiya Ladekabel vergoldet
Charging cable Tamiya gold

500405344

Querlenkerhalter Set v/h
Suspension arm holder set f/r

500405360

Servosaver / Lenkeinheit
Servosaver / steering set

500405361

Rutschkupplung-Set + Zahnrad
Slipper clutch set + gear

500405362

Differenzial vorne komplett
Diff complete front

500405363

Differenzial hinten komplett
Diff complete rear

500405417

Dämpferbrücke/Getriebe geh. Set
Shock tower/gear box set

500405419

2x Antriebswellen hi + Achsen
2x Rear dogbone + drive cup

500405420

Querlenker Set + Halter v/h
Suspension arm + holder f/r

500405422

Chassis/Anbauteile-Set
Chassis plates replacement set

500405423

Motorritzel 21 Z
Pinion gear 21 T

500405424

7x Gestänge-Set
7x Full turnbuckle set

500405692

LED-Light Set X10
LED-Light Set X10

500908181

Montageständer f.1:10/1:8(Aluminium)
Car stand 1:10/1:8 (Aluminium)

500405757

1:10 Alu Stoßdämpfer (2) 85mm
1:10 Alu Oil Damper Set (2) 85mm

500405758

1:10 Alu Stoßdämpfer (2) 100mm
1:10 Alu Oil Damper Set (2) 100mm

500405863

1:10 Alu Stoßdämpfer (4) 55mm
1:10 Alu Oil Damper Set (4) 55mm

500405864

1:10 Alu Stoßdämpfer (4) 62mm
1:10 Alu Oil Damper Set (4) 62mm

500105200

1:10
4WD
On-Road Reifen-/Felgen Set Ø 83 mm 4WD
On-Road Tyre/rim set Ø 83 mm 4WD

500900047

1:10
4WD
Off-Road Ø ca. 105 mm
Off-Road Ø about 105 mm

500900049

1:10
4WD
Off-Road Ø ca. 105 mm
Off-Road Ø about 105 mm

Off-Road-Line

LAND ROVER DEFENDER

 45

MC-10 MOUNTAIN WARRIOR

 46

LAND ROVER DEFENDER

 45

X-CRAWLEE PRO 2.0

 49

MOUNTAIN WARRIOR SPORT 2.0

 47

X-CRAWLEE 4WD

 48

X-CRAWLEE XL BEETLE

 50

X-CRAWLEE 4WD

 48

OFF-ROAD LINE – DIE SPEZIALISTEN FÜR GROBES GELÄNDE

Trial oder HighSpeed durch Gelände? Dann finden Sie hier die passenden Modelle. Die Fahrzeuge bieten je nach Anspruch extreme Geländegängigkeit mit verschränkbaren Achsen und LowPressure Reifen sowie langen Federwegen. Viele Aluminium Tuningteile wie Öldruckstoßdämpfer sind schon verbaut, aber rundet wird die Ausstattung teilweise mit LED Front- und Rückleuchteinheiten sowie wasserfeste RC-Komponenten. Die störungsfreie 2.4 GHz Reflex Wheel Fernsteuerung ist nur eine von vielen Ausstattungsmerkmalen dieser OffRoad-Spezialisten. Dank dem 100% Komplett-Lieferumfang sind die CARSON OffRoad-Line Fahrzeuge sofort startbereit. Kaufen, laden – fahren!

OFF-ROAD LINE – THE SPECIALISTS FOR ROUGH TERRAIN

Trial or high-speed through open country? You'll find the right models here. Depending on requirements, the vehicles offer extreme off-road capability with articulating axles and low-pressure tyres as well as long suspension travel. Many aluminium tuning parts, such as oil-filled shock absorbers, are already installed. The equipment is rounded off in some cases with LED front and rear light clusters and waterproof RC components. The interference-free 2.4 GHz Reflex Wheel remote control is just one of many equipment features of these off-road specialists. Since they come with everything included, the CARSON OffRoad line models are ready to race straight away. Purchase, charge – race!

- 8+** **4WD** **STOPP** **2**
channel
- Federung** **1:8**
- 20 km/h** **1.790 g** **2.4 G** **100 m**
- 20 min** **2,0 h** **Lilon**
- 7.4V** **4x AA** **1.200 mAh**
- Brushed** **Typ 380** **500 mm**



500608255

Ersatzakku / Additional battery 7.4V / 1200 mAh



Orange Version

N° 500404171 (Orange Version) /
 N° 500404172 (Silver Version)
 1:8 Land Rover Defender 2.4 GHz 100% RTR



N° 500404094

1:10 MC-10 Mountain Warrior 2.4 GHz 100 % RTR

- 14+
- 4WD
- STOPP
- 2 Channel
- 1:12
- 1.142 g
- 2.4 G
- 60 m
- 30 min
- 2,0 h
- Lilon
- 850 mAh
- 4x AA
- 3 kg
- Brushed
- Typ 380
- 370 mm



500608254

Ersatzakku / Additional battery 7.4V / 850 mAh



N° 500404197

1:12 Mountain Warrior Sport 2.0 2.4 GHz 100% RTR



N° 500404067 (Sand Version) /
N° 500404068 (Green Version)
1:10 X-Crawlee XL 2.4 GHz 100% RTR

Green Version



**NEU
NEW**

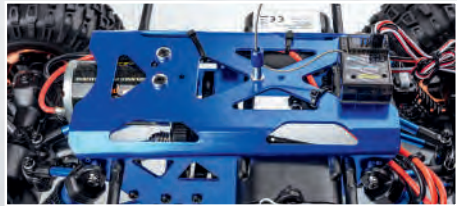

N° 500404214
1:10 X-Crawlee Pro 2.0 2.4 GHz 100% RTR



N° 500404169

1:10 X-Crawlee XL Beetle 2.4 GHz 100% RTR



500405598

Gestängeset (10)
Linkage Set (10)

500405611

Motorritzel
Pinion gear

500405614

Mittelantriebswellen / Schrauben
Center drive shafts / screws

500405615

Rutschkupplung- / Zahnrad-Set
Main gear / slipperclutch set

500405616

Stoßdämpfer (2)
Shock absorbers (2)

500405617

Schraubensatz
Screw set

500800088

Karoseries X-Crawlee Pro
Bodyset X-Crawlee Pro

500608024

Akku 7,2 V / 3500 mAh
Battery 7,2 V / 3500 mAh

500503028

Ladekabel Tamiya
Charging cable Tamiya

500606053

Expert Charger xBase 2.0 se mit LiPo-Funktion / Expert Charger xBase 2.0 se with LiPo function

500405649

4WD Lenkgestänge X-Crawlee Pro
4WD Steeringkit X-Crawlee Pro

500502046

Servo für X-crawlee PRO hinten (9Kg)
Rear servo for X-crawlee PRO (9Kg)

500607013

Expert Charger NiMH Compact 4A Lade Set
Charger Set Expert Charger NiMH Compact 4A

500908060

Karosserieklammern 24 mm 1:10 Modelle
Je 10 Stück / body braces 24 mm 1:10 Models
à 10 pieces



CY-Line



CY-E SPECTER TWO PRO BL 6S

54

CY LINE – DAS CHASSIS MIT DEN WELTREKORD-GENEN

Der CARSON Specter Brushless 6S ist der innovative 4WD Buggy mit einem für Off Road-Pisten optimierten Race-Chassis und kraftvollem Brushless-Antrieb. Um das Lenkservo vor Feuchtigkeit zu schützen, wurde das Gehäuse abgedichtet. Das robuste 3 mm Alu-Chassis hat je eine Chassisstrebe vorne und hinten. Massive Querlenker und umlaufende Schmutzabweiser sorgen für langanhaltenden Fahrspaß. Der 2200 kV Brushless-Motor liefert dem Allradantrieb massig Power und beschleunigt den Specter auf bis zu 100 km/h. Der komplette Antriebsstrang wird aus extrem robusten und gehärtetem Stahl gefertigt. Die enorme Power des leistungsstarken neuen SHOOTER 6S Brushless Motors wird über 3 SPIDER Differenziale auf alle vier Räder verteilt. Big Bore Alu-Öldruckdämpfer, der tiefe Schwerpunkt und zahlreiche Setup-Optionen sorgen für perfekte Bodenhaftung und lassen den CARSON Specter Brushless 6S über alle Strecken fliegen.

CY LINE – CHASSIS WITH WORLD RECORD GENES

The CARSON Specter Brushless 6S is the innovative 4WD buggy with a race chassis optimised for off-road tracks and powerful brushless drive. To protect the steering servo from moisture, the housing was sealed. The robust, 3-mm aluminium chassis has a chassis crossbeam front and rear. Massive control arms and all-round dirt deflectors make for hours of driving fun. The 2200 kV brushless motor delivers even power to the all-wheel drive and accelerates the Specter up to 100 km/h. The complete drive train is made from extremely robust, hardened steel. The enormous power of the high-performance new SHOOTER 6S brushless motor is distributed over all four wheels by means of 3 SPIDER differentials. Big Bore aluminium oil pressure shock absorbers, the low centre of gravity and numerous set-up options provide perfect track-holding and enable the CARSON Specter Brushless 6S to fly over any course.





Specter Two Brushless Pro 6S RTR

Der neue Specter brushless 6S mit dem neuen Brushless Antrieb bis 22,2V/ 6S LiPo! Jetzt noch besser! Der komplette Antriebsstrang wird aus extrem robusten und gehärtetem Stahl gefertigt. Die enorme Power des leistungsstarken neuen SHOOTER 6S Brushless Motors wird über 3 SPIDER Differenziale auf alle vier Räder verteilt. Das Fahrwerk verfügt über viele Einstellmöglichkeiten um das Modell auf jeden Untergrund perfekt abzustimmen.

Technische Daten: Allradantrieb • 3 Stahldifferenziale • gehärtete Antriebswellen • gehärtete CNC-gefräßte Zahnräder • 3 mm Alu-Chassis mit versenkten Schrauben • Chassisverstrebung hinten und vorne • einstellbare Öldruckstoßdämpfer • Heckspoiler einstellbar • 17 mm Felgenmitnehmer • fertig verklebte Racing High-Gripp Reifen mit Einlagen auf Speichenfelgen • C-Hubs mit Alu-Achsschenkel • kugelgelagert.

NEU

- Akkuhalter
- Dämpferbrücke
- Aluteile in Titan Color
- Wasserfest
- Reflex Wheel PRO 3 LCD 2.4G

The World Record RC-Car!

The new Specter brushless 6S with the new brushless drive up to 22.2V/ 6S LiPo! The complete drive train is made from extremely robust and hardened steel. The enormous power of the high performance new SHOOTER 6S brushless motor is distributed across 3 SPIDER differentials to all four wheels. The chassis features a wide range of adjustment options in order to adapt the model perfectly to any type of surface.

Technical data: Four-wheel drive • 3 steel differentials • hardened drive shafts • hardened CNC-milled toothed gears • 3 mm aluminium chassis with countersunk screws • chassis struts rear and front • adjustable oil shock absorbers • adjustable rear spoiler • 17 mm wheel hub • ready-bonded racing high-grip tyres with inserts on spoked wheels • C-hubs with aluminium steering stub axles • with ball bearing.

NEW

- Battery holder
- Damper bridge
- Alu parts in Titan
- Waterproof
- Reflex Wheel PRO 3 LCD 2.4G



 **HOBBYWING®**

N° 500409006

1:8 CY-E Specter Two Pro BL 6S 2.4 GHz RTR

500205431

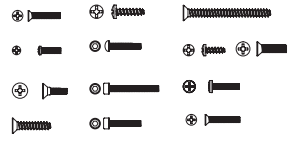

Schraubenset 1
Screw set 1

500205432

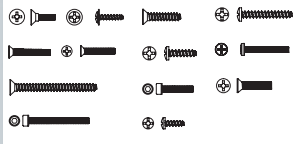

Schraubenset 2
Screw set 2

500405110



Antriebsritzel 15 Z.
Pinion gear 15 T.

500405119

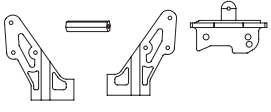

Spoilerhalter
Spoilerholder

500205435

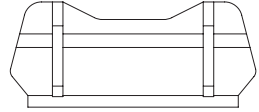

Frontrammer
Front Bumper

500205437

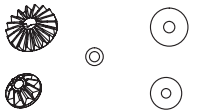

Differenzial Getriebe
Differential gears

500205438

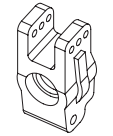

Achsschenkel hinten
Rear hub carrier

500205441

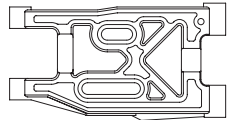

Querlenker hinten unten
Rear lower suspension arm

500205449

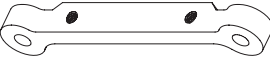

Querlenkerhalterung vorne oben
Front upper suspension mount

500205455

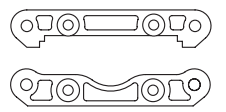

Querlenkerhalterung vorne unten
Front lower suspension mounts

500205456

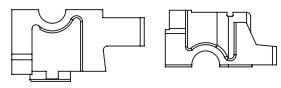

Getriebegehäuse
Gear housing

500205458

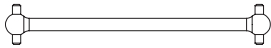

2x Antriebswelle hinten
2x Rear drive shaft

500205464



Zahnrad 46 Z Stahl
Steel spur gear 46T

500205472

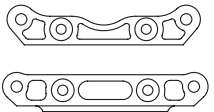

Querlenkerhalterung hinten unten
Rear lower suspension mounts

500205473



Servosaverteile 1
Steering Bell cranks

500205482

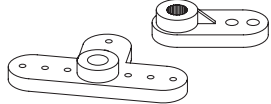

CY-2 Servohörner
CY-2 Servo Horns

500205687

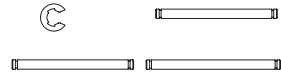

CY-2 Querlenkerst. u. Pins vorne
CY-2 Hing pins and clips

500908047



4x Radmutter
4x Hex wheel nut

500205701

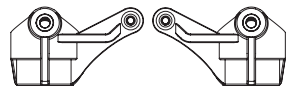

Achsschenkel L/R
Steering set l/r

500205706

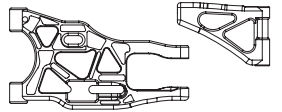

2x Querlenker-Set vorne
2x Front arm kit

500205707

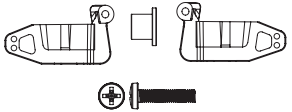

CY-2 C-Hub vorne
CY-2 C-Hub front

500205516

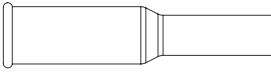

4x Dämpferstaubschutz
4x Dust cover set

500205742



2x Stoßdämpfer vorne (Plastik)
2x Front shock (plastic)

500405201

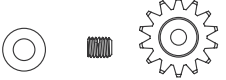

Motorritzel 14Z Specter 6S
Pinion gear 14T Specter 6S

500801010



Karosserie + Spoiler + Dekor
Body + tail wing + Decals

500900098



Reifenset
Tyre set

500608102



Ersatzakku / Optional Battery 11,1V/3100mAh
LiPo 40C

500609042



Mignon-Set NiMH Akkus AA 1,2V (4)
Mignon-Set NiMH rechargeable batteries AA 1,2V (4)

500013629



Ladekabel mit Kreustecker
Charging cable for transmitter

500906081



Ladekabel T-Plug
charging cable T-Plug

500608190



Expert Charger Duo 2.0
Expert Charger Duo 2.0

500908133



Transporttasche
Car Bag TAMIYA Fighter

500908062



Karosseriekammern 27 mm 1:8 Modelle
je 10 Stück / body braces 27 mm 1:8 Models
à 10 pieces

500502042



Servo CS-9 waterproof 9kg/JR Stecker
Servo CS-9 waterproof 9kg/JR Plug



Tuningteile CY-E / tuning parts CY-E

500906092



Y-Kabel Serie-Schaltung /
Y-cable serial

Y-Kabel Serie-Schaltung /
Y-cable, connection in serial

Erforderlich, wenn eine Fahrspannung von 14,8V bei den 1:8er Brushless-Modellen gewünscht wird. Zur Verbindung von 2 x 7,4 V LiPo Akkupacks.
/ Required for 1:8 scale buggy models for double run time. To connect two 7.4 V LiPo battery packs in 14.8 V.

500906143



Programmier-Box Dragster II
Programming-Box Dragster II

Y-Kabel Serie-Schaltung /
Y-cable, connection in serial

Erforderlich, wenn eine Fahrspannung von 14,8V bei den 1:8er Brushless-Modellen gewünscht wird. Zur Verbindung von 2 x 7,4 V LiPo Akkupacks.
/ Required for 1:8 scale buggy models for double run time. To connect two 7.4 V LiPo battery packs in 14.8 V.

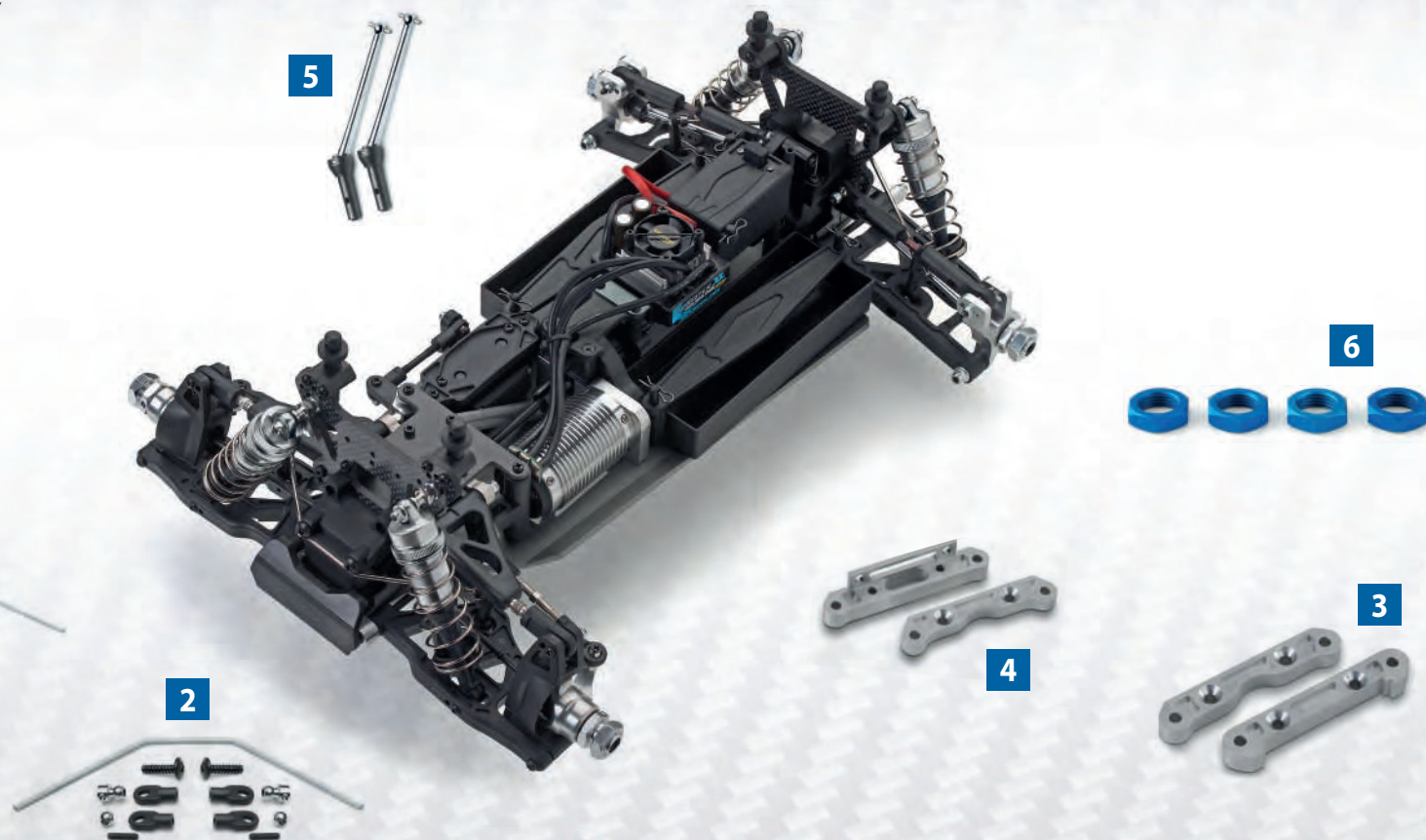

| | | Buggy |
|---|---|-------|
| 1 | 500205512 Stabilisator hinten / Anti-roll-bar rear | X |
| 2 | 500205513 Stabilisator vorn / Anti-roll-bar front | X |
| 3 | 500205716 Aluminium Querlenker vorn / Front lower suspension mount aluminium | X |
| 4 | 500205723 Aluminium Querlenkerhalter hinten / Real lower suspension mount aluminium | X |
| 5 | 500205514 Tuning-Kardanwellen hinten / Universal drive shafts rear | X |
| 6 | 500908047 Radmuttern M12x1,25 Alu blau (4) / Wheel nuts M12x1,25 alu blue (4) | X |

Virus-Line



VIRUS RACE 4.2 4S BRUSHLESS
 □ 62



VIRUS 4.1 XL 4S
 □ 63



VIRUS 4.1 BRUSHLESS 4S
 □ 59



VIRUS ROCKET 120 6S
 □ 60

DAS VIRUS-CHASSIS IST DAS JÜNGSTE MITGLIED IN DER CARSON HIGH-END-KLASSE

CNC gefertigte Aluminiumteile runden die Performance dieses Chassis ab und verleihen im auf jedem Untergrund ausreichende Stabilität. Viele Einstellmöglichkeiten wie die Alu Big-Bore Stoßdämpfer lassen keinen Wünsche in Sachen Setup offen. Die neueste Evolutionstufe bildet den VIRUS 6S und VIRUS Truggy 4S. Wasserfeste RC-Komponenten ermöglichen Renneinsätze unter widrigen Wettereinflüssen. Die Modelle verfügen über ein vorinstalliertes 2.4G RC-System.

THE VIRUS CHASSIS IS THE MOST RECENT ADDITION TO CARSON'S HIGH-END CLASS

CNC manufactured aluminium parts round off the performance of this chassis and give it adequate stability for any surface. Many adjustment options such as those of the aluminium big-bore shock absorbers leave nothing to be desired as regards set-up. The VIRUS 6S and VIRUS Truggy 4S chassis are the latest evolutionary stage. Watertight RC components allow races to be conducted under adverse weather conditions. The models come with a pre-installed 2.4G RC system.



BRUSHED / BRUSHLESS

HOBBYWING®

N° 500409061

1:8 Virus 4.1 4S Brushless 2.4 GHz 100% RTR



100% RTR



RTR



THW HOBBYWING®

N° 500409073 (RTR Version)
 N° 500409072 (100% RTR Version)
 1:8 Virus Rocket 120 6S 2.4 GHz

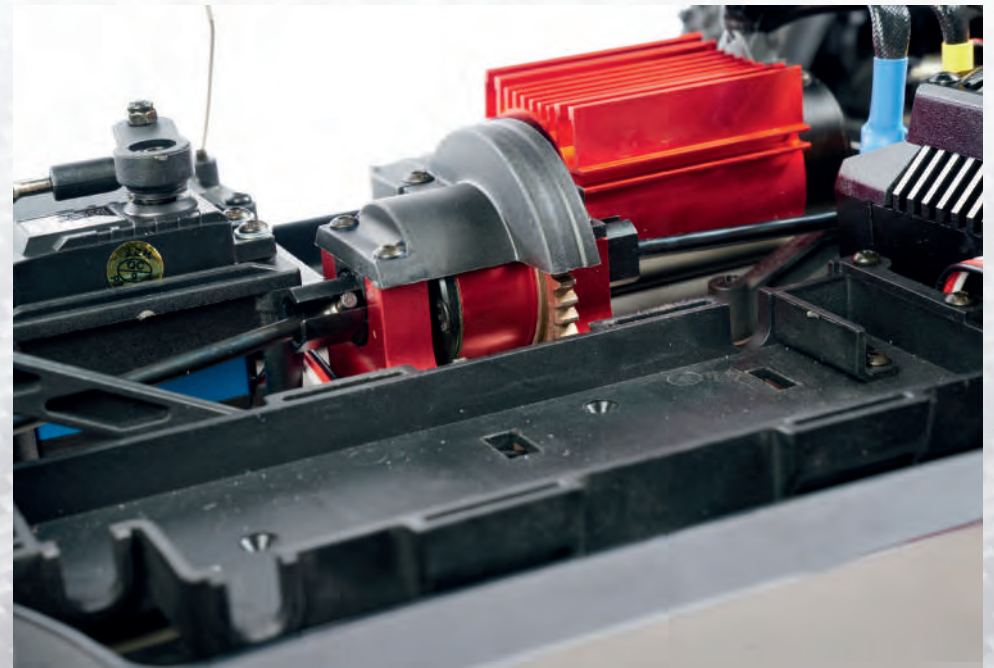
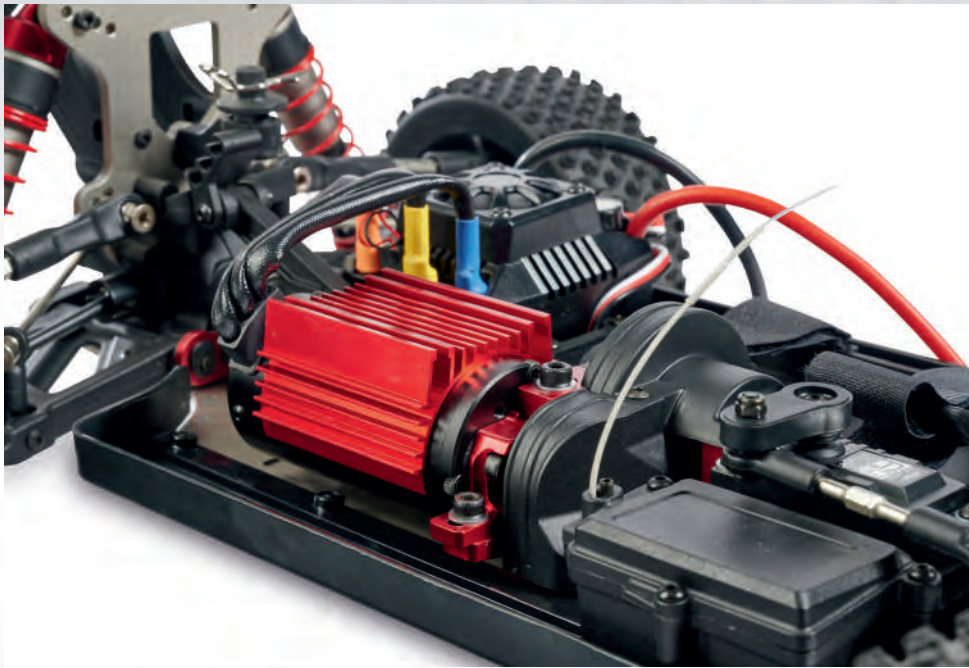



100% RTR



RTR



N° 500409068 (RTR Version)
N° 500409069 (100% RTR Version)
1:8 Virus Race 4.2 4S Brushless 2.4 GHz





**NEU
NEW**



THW HOBBYWING®

N° 500409067

1:8 Virus XL 4.1 4S 2.4 GHz RTR





500205924

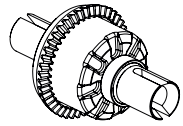

Diff vorne/hinten komplett
Diff front/rear complete

500205925

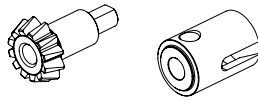

Kegelzahnrad/Mitnehmer
Bevelgear/joint cup

500205927

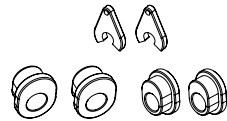

Querlenkeraufnahme-Set
Lower arms support

500205928

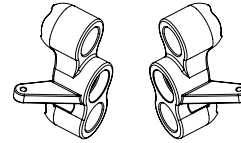

Lenkhebel vorne (2)
Steering set (2)

500205929

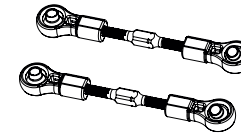

Lenkgestänge (2)
Steering linkage (2)

500205936

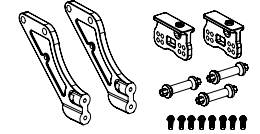

Spoilerhalterung
Wing mount posts

500205937

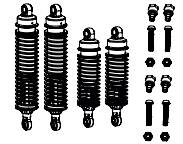

Alu Stoßdämpfer-Set v/h
Alu Shocks-kit v/h

500205938

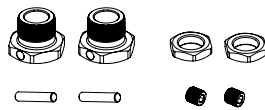

Alu-Felgenmitnehmer 17mm
Alu-hex hub 17mm

500205939

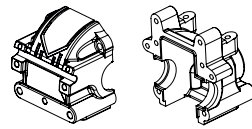

Getriebegehäuse
Gear housing

500205940

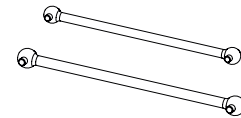

Mittelantriebswellen (2)
Dog bone center (2)

500205941

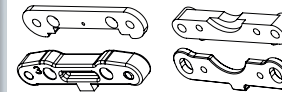

Querlenkerhalter-Set
Lower suspension mount-kit

500205942

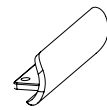

Frontrammer
Front bumper

500205943

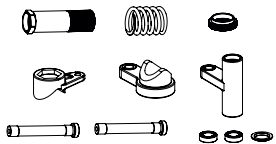

Servosaver-Einheit
Servosaver-Unit

500205945

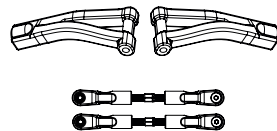

Querlenker-Set oben (4)
Upper front/rear tie-rod kit (4)

500205946

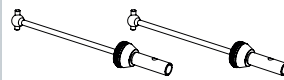

Kardanwellen vorne (2)
Front drive shafts (2)

500205947

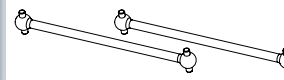

Antriebswellen hinten (2)
Dog bone rear (2)

500205948

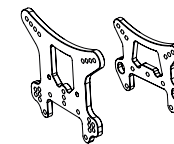

Dämpferbrücken v/h
Shock-tower f/r

500205949

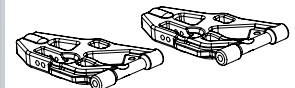

Querlenker-Set unten vo. (2)
Lower Arms kit front (2)

500205950

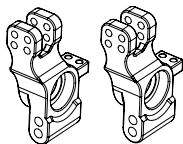

Achsschenkel hinten
Rear hub carrier

500205957

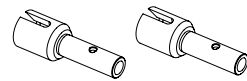

Achsen hinten (2)
Axles rear (2)

500205958

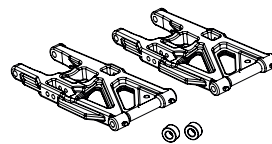

Querlenker-Set unten hi. (2)
Lower arms kit rear (2)

500405586

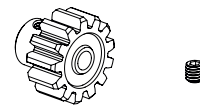

Motorritzel
Piniongear

500801020

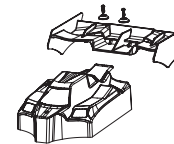

Karosserie + Spoiler VIRUS 4.1
Body + Wing VIRUS 4.1

500405592

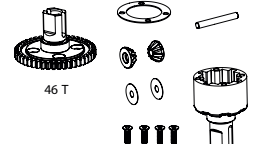

Mitteldiff komplett
Centerdiff complete

500405621

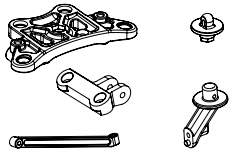

Karosseriehalter-Set
Bodyholder-Kit

500405767

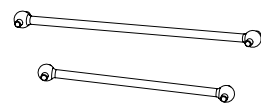

65 Zentralantriebswelle
65 Center drive shaft

500405770

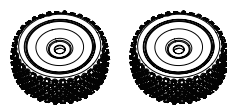

65 Reifenset (2)
65 Wheelset (2)

500900075



Buggy Reifen-/Felgen-Set Ø 110 mm
schwarz (2) / Buggy tyre/rim set Ø 110 mm
black (2)

500908133



Transporttasche
Car Bag TAMIYA Fighter

500609042



Mignon-Set NiMH Akkus AA 1,2V (4)
Mignon-Set NiMH rechargeable batteries AA 1,2V (4)

500013629



Ladekabel mit Kreuzstecker
Charging cable for transmitter

500906081



Ladekabel T-Plug
charging cable T-Plug

500608190



Expert Charger Duo 2.0
Expert Charger Duo 2.0

500908062



Karosserieklammern 27 mm 1:8 Modelle
je 10 Stück / body braces 27 mm 1:8 Models
à 10 pieces



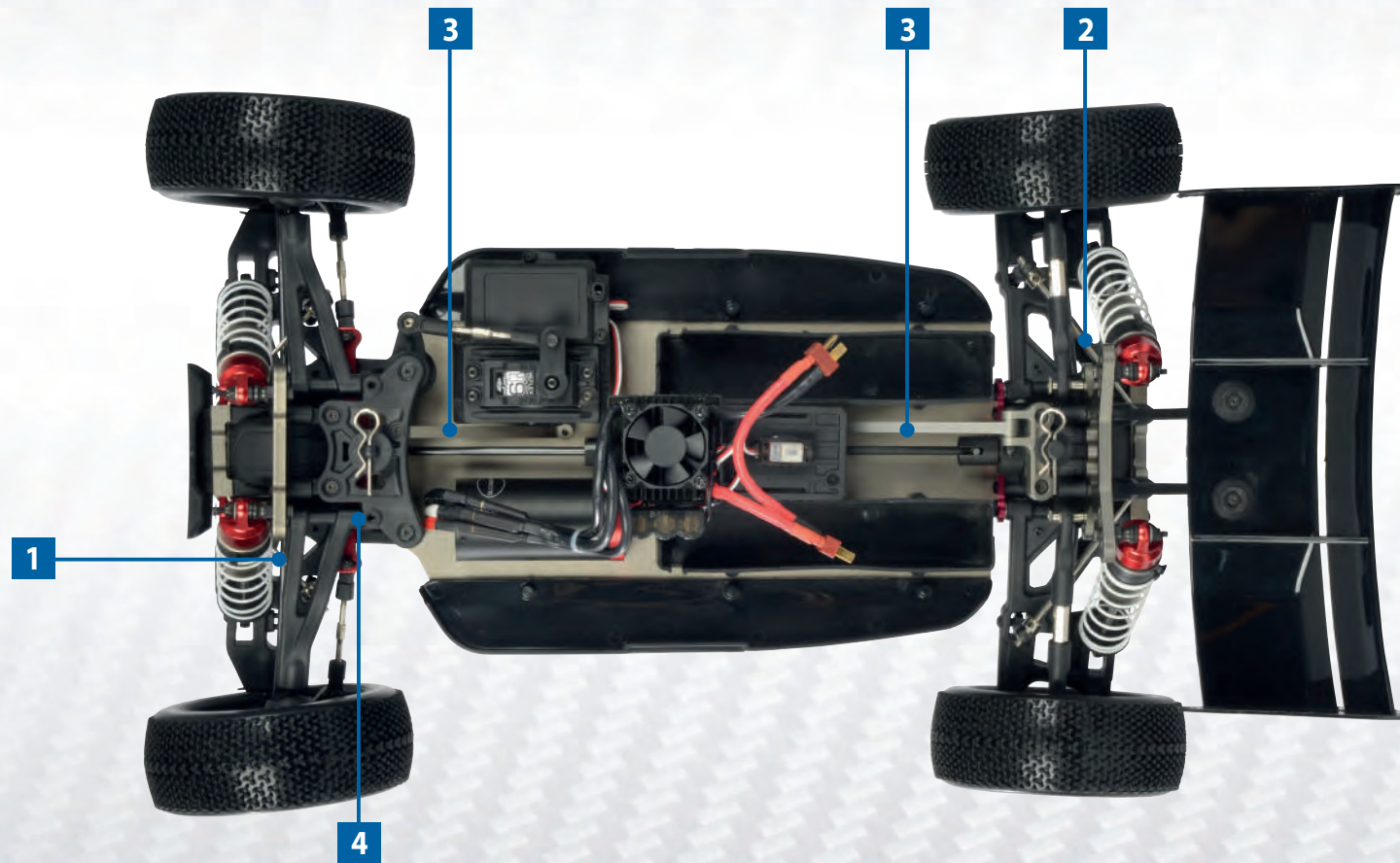

| | | | |
|---|-----------|---|-------|
| 1 | 500205963 | Stabilisator-Satz vorn Virus 4.0 / Virus 4.0 Front Sway Bar Kit | EP/GP |
| 2 | 500205964 | Stabilisator-Satz hinten Virus 4.0 / Virus 4.0 Rear Sway Bar Kit | EP/GP |
| 3 | 500205965 | Alu Chassis-Versteifung vo/hi, Virus 4.0 / Virus 4.0 Chassis Brace Set front/rear | EP/GP |
| 4 | 500205971 | Alu Halter Querlenker vorn (1) Virus 4.0 / Virus 4.0 Front Toe in Plate | EP/GP |

STORMRACER EXTREME PRO

69



CV-Line



VW SCIROCCO

72

DIE CARSON CV-LINE BIETET MIT IHREM ALLROUND-CHASSIS DEN PERFEKTEN EINSTIEG IN DEN VERBRENNER RC-MODELLSPORT

Das überarbeitete Chassis besitzt vom Fahrwerk bis zur Scheibenbremsanlage je nach Einsatz optimale Setup Möglichkeiten. Der verbaute FORCE-Nitro Hochleistungsmotor kann mittels praktischen Seilzug gestartet werden und lässt sich einfach einstellen. Die ausgeklügelte Fahrwerksgeometrie erlaubt das Verbauen von gleichen Ersatzteilen an Vorder- und Hinterachseinheit. Die Modelle verfügen über ein vorinstalliertes 2.4G RC-System.

WITH ITS ALL-ROUND CHASSIS, THE CARSON CV LINE OFFERS THE PERFECT ENTRY INTO THE WORLD OF COMBUSTOR RC MODEL SPORT

Optimal set-up options depending on use exist for the revised chassis, from the suspension to the disk brake system. The installed FORCE high performance nitro engine can be started with a convenient pull cord and is easy to adjust. The cleverly devised suspension geometry allows identical spare parts to be fitted to the front and rear axle units. The models come with a pre-installed 2.4G RC system.





N° 500103020

1:10 CV-10 Stormracer Extreme Pro 2.4 GHz RTR

500905082

Nitro-Set
Nitro Set

500905191

Nitro Treibstoff 16%
Nitro Fire Fuel 16%

500609042

Mignon-Set NiMH Akkus AA 1,2V (4)
Mignon-Set NiMH rechargeable batteries AA 1,2V (4)

500608104

Empfängerakku 1600 mAh
Receiver battery 1600 mAh

500606053

Expert Charger xBase 2.0 se
Expert Charger xBase 2.0 se

500013312

Ladekabel BEC-Stecker
Charger cable BEC

500105119

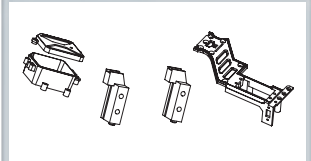
RC-Box/Servohalter/Upperdeck
RC-box/servo mount/upperdeck

500105120

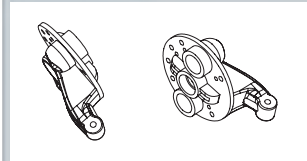
2x Achsschenkel-Set vo/hi/li/re
2x Upright-set fr/re/le/ri

500105122

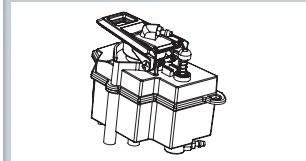
75 ml Kraftstofftank
75 ml Fuel Tank

500105123

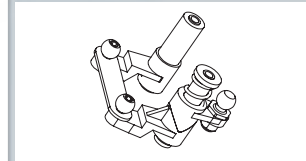
Lenkung/Servo-Saver-Set
Steering/servo-saver-set

500105124

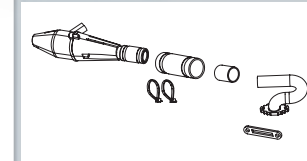
Krümmer-/Resonanzrohr-Set
Manifold/tuned-pipe-set/connector

500105130

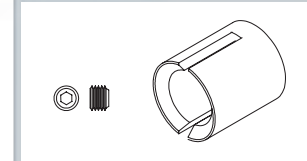
2x Mitnehmer Getriebe-Seite kurz
2x Universal joint gearbox short

500105140

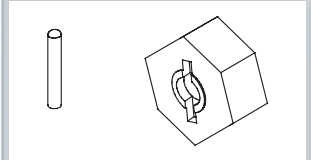
4x Felgenmitnehmer 12mm-Kant+Stift
4x Wheel Hex w/pin (4) 12 mm

500105141

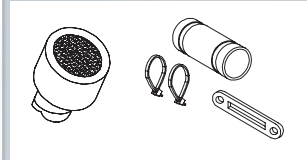
Luftfilter-Set
Air cleaner-set

500105144

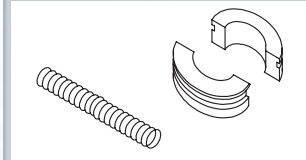
3-Backenkupplung mit Feder
3-Shoe clutch with spring

500105160

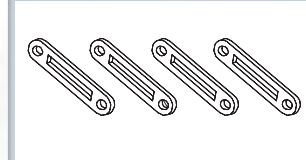
4x Krümmerdichtung
4x Manifold gasket-set

500105170

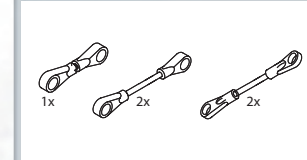
Lenkgestänge-Set
Steering rod set

500105173

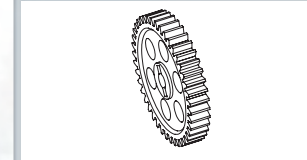
2x Hauptzahnrad
2x Main gear

500105174

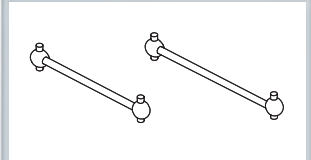
Antriebswellen-Set Mitte
Center Dogbone-set

500105286

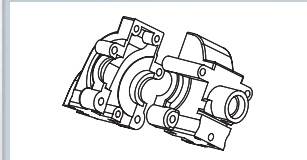
Getriebegehäuse vorne/hinten
Gear housing front/rear

500405133

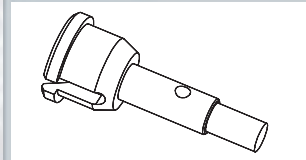
2x Radachsen-Set
2x Wheelaxle-set

500905081

EMS-PRO Motor Start System
Starter Kit

500013117

Ladekabel für Glühkerzenstecker
Charging cable for glow plug igniters

500905061

Akku-/Glühkerzenstecker-Set 230V mit
integriertem 2500 mAh NiMH-Akku; 600 mA
Ladestrom / Battery/glow plug igniter set, 230 V

500905078

Tankfüllflasche 300 ml
Fuel bottle 300 ml

500905065

Glühkerzenschlüssel
Wrench

500054648

Force Seilzugstarter ohne Flansch
Pullstart

500905011

Glühkerze Rossi R7 kalt
glowplug Rossi R7 cold

500905070



Auspuff Chrom
Power Pipe chrom 1:10

500905193



Luftfilteröl 50 ml
Air Filter Oil

500905194



Afterrunöl 50 ml
After Run Oil

500906128



Micro-Fail Safe wasserdicht
Micro-Fail Safe waterproof

500908162



Corner Marker-Set NEON, Ø 13,5 cm (9 St.)
Corner Marker-Set, Ø 13,5 cm (9 Pc.)

500105200



On-Road Reifen-/Felgen Set Ø 83 mm 4WD
On-Road Tyre/rim set Ø 83 mm 4WD

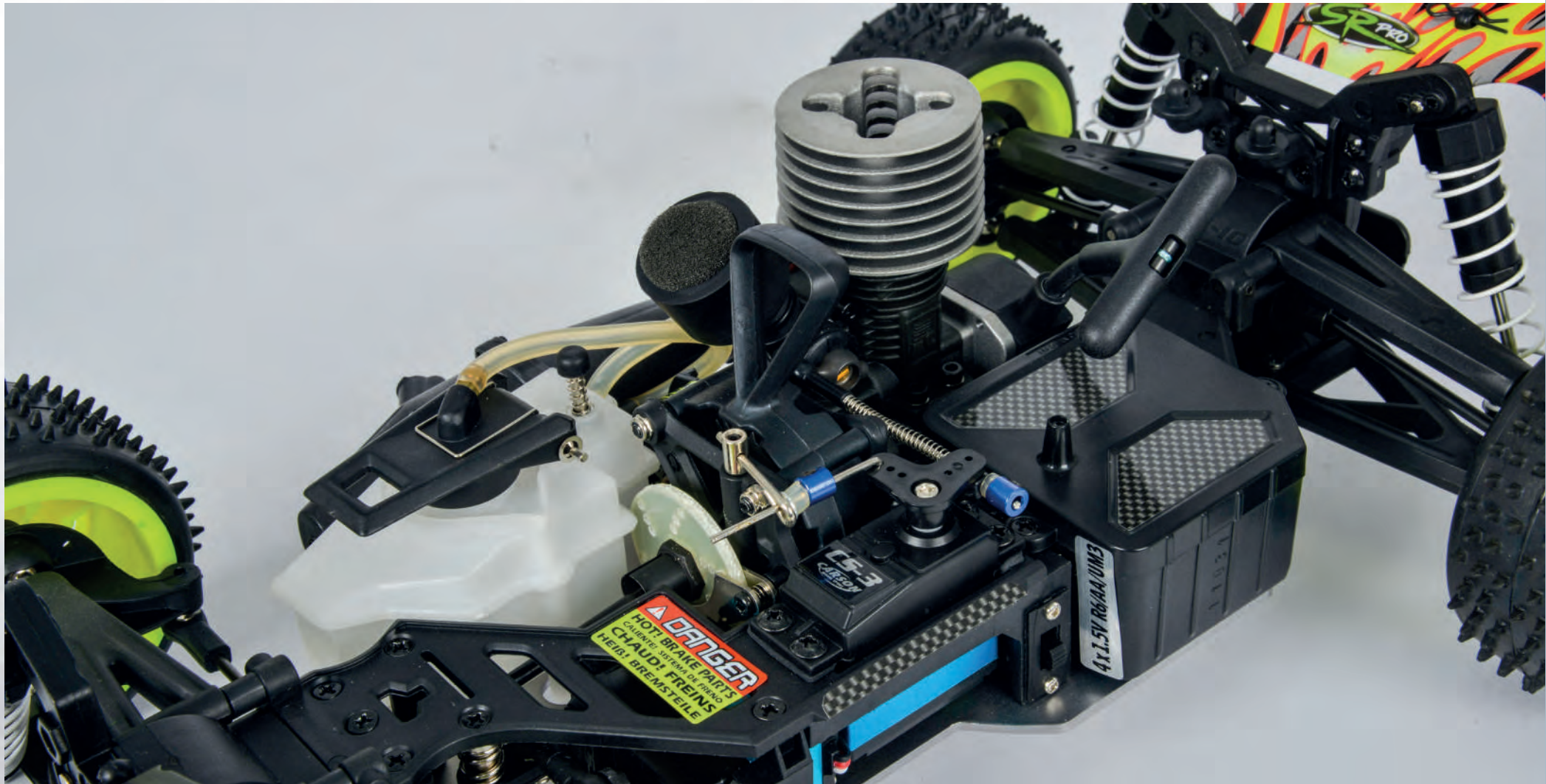

Ersatzteile / Spare parts

Optionales Zubehör / Option parts



N° 500103038

1:10 CV-10 VW Scirocco 2.4 GHz RTR 2,5ccm

500905082



Nitro-Set
Nitro Set

500905191



Nitro Treibstoff 16%
Nitro Fire Fuel 16%

500609042



Mignon-Set NiMH Akkus AA 1,2V (4)
Mignon-Set NiMH rechargeable batteries AA 1,2V (4)

500608104



Empfängerakku 1600 mAh
Receiver battery 1600 mAh

500606053



Expert Charger xBase 2.0 se
Expert Charger xBase 2.0 se

500013312



Ladekabel BEC-Stecker
Charger cable BEC

500105119

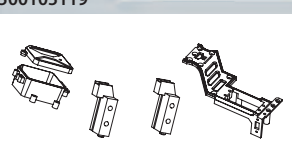

RC-Box/Servohalter/Upperdeck
RC-box/servo mount/upperdeck

500105120

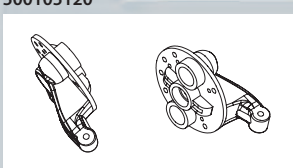

2x Achsschenkel-Set vo/li/re
2x Upright-set fr/re/le/ri

500105122

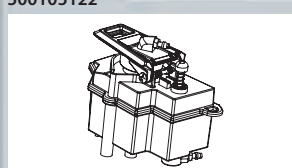

75 ml Kraftstofftank
75 ml Fuel Tank

500105123

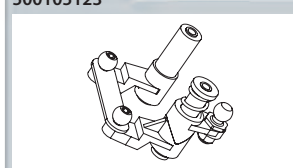

Lenkung/Servo-Saver-Set
Steering/servo-saver-set

500105124

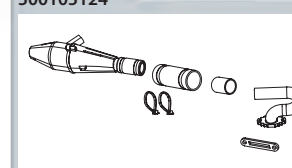

Krümmer-/Resonanzrohr-Set
Manifold/tuned-pipe-set/connector

500105127

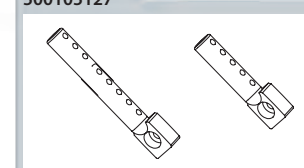

4+4 Karosseriehalter-Set
4+4 Body mount-set

500105130



2x Mitnehmer Getriebe-Seite kurz
2x Universal joint gearbox short

500105131

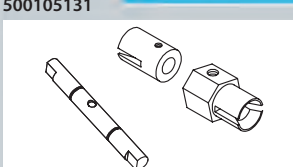

Haupt-Getriebewelle+Mitnehmer-Set
Main-gear-shaft w/ 2 joint-Set

500105140

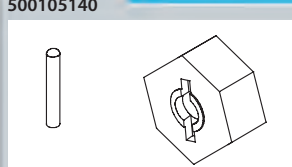

4x Felgenmitnehmer 12mm-Kant+Stift
4x Wheel Hex w/pin (4) 12 mm

500105141



Luftfilter-Set
Air cleaner-set

500105144

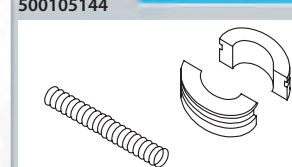

3-Backenkupplung mit Feder
3-Shoe clutch with spring

500105154

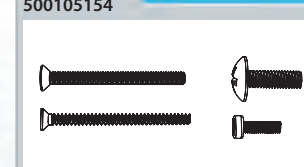

Schrauben-Set 87-teilig
Screw-set, 87 pieces

500105160

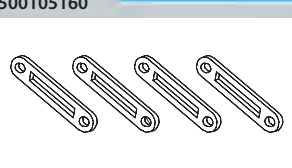

4x Krümmerdichtung
4x Manifold gasket-set

500405133

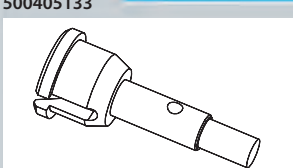

2x Radachsen-Set
2x Wheelaxle-set

500800051



Karosserie VW Scirocco, lackiert
Body VW Scirocco, painted

500105286

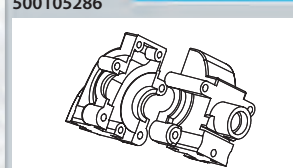

Getriebegehäuse vorne/hinten
Gear housing front/rear

500800059



Karosserie Porsche GT3, weiß lackiert
Body Porsche GT3, painted white

500054648



Force Seilzugstarter ohne Flansch
Pullstart

500900084



Big Wheel Set 1 schwarz-chrom
Big Wheel Set 1 black-chrome

500608104



Empfängerakku 1600 mAh
Receiver battery 1600 mAh

500013117



Ladekabel für Glühkerzenstecker
Charging cable for glow plug igniter

500905061



Akku-/Glühkerzenstecker-Set 230 V mit integriertem 2500 mAh NiMH-Akku; 600 mA Ladestrom / Battery/glow plug igniter set, 230 V

500905078



Tankfüllflasche 300 ml
Fuel bottle 300 ml

500905081



EMS-PRO Motor Start System
Starter Kit

500905082

Nitro-Set
Nitro Set

500905011

Glühkerze Rossi R7 kalt
glowplug Rossi R7 cold

500901008

Force Motor 15S/2,5ccm O.S.-Welle
Force Motor 15S/2,5ccm OS-Welle

500905065

Glühkerzenschlüssel
Wrench

500105210

2-Gang, alle On Road-Varianten
2-speed, all on-road versions

500905070

Auspuff Chrom
Power Pipe chrom 1:10

500908115

Antennenrohre schwarz (4 St)
Antenna tube black (4 pcs.)

500905193

Luftfilteröl 50 ml
Air Filter Oil

500905194

Afterrunöl 50 ml
After Run Oil

500900080

Big Wheel Set 2 schwarz-chrom
Big Wheel Set 2 black-chrome

500908162

Corner Marker-Set NEON, Ø 13,5 cm (9 St.)
Corner Marker-Set, Ø 13,5 cm (9 Pcs.)

500908181

Montageständer f.1:10/1:8(Aluminium)
Car stand 1:10/1:8 (Aluminium)

500908060

Karosseriekammern 24 mm 1:10 Modelle
je 10 Stück / body braces 24 mm 1:10 Models
à 10 pieces

CY-Line

CY SPECTER X V36

76



CY NITRO – DAS CY NITRO-CHASSIS AUF DEM NEUESTEN STAND

Die CARSON CY-Line baut auf dem bewährten und stets weiterentwickelten CY-Chassis auf und bietet dem RC-Fahrer zahlreiche Set-Up Möglichkeiten um auf jedem Untergrund beste Traktion zu haben. Die Alu-Lenkhebel wurde optimiert um die Lenkung noch leichter und effizienter zu machen. Die Fahrwerksgeometrie mit Öldruckstoßdämpfer und der Antriebsstrang aus gehärtetem Stahl bringt die Leistung der Force-Verbrennungsmotoren bestens auf die Piste. Durch das 2-Scheiben Bremsssystem ist die Vorder-Hinterachse separat einstellbar und bietet in kritischen Situationen genug Reserven um den Specter unter Kontrolle zu halten. Alle CARSON CY-Modelle sind komplett Kugelgelagert und verfügen über verklebte HighGrip-Radsätze. Je nach Ausführung beinhaltet der Lieferumfang die CARSON 2.4 GHz ReflexWheel Fernsteueranlage.

CY NITRO – THE CY NITRO CHASSIS UP-TO-DATE

The CARSON CY line builds upon the proven CY chassis, which is under continual advancement, and offers the RC driver numerous set-up options to achieve the best possible traction on any surface. The aluminium steering arm has been optimised to make the steering even lighter and more efficient. The chassis geometry with oil pressure shock absorbers and a hardened steel drive train deliver the Force combustion engine's output to the track optimally. By virtue of the dual disk braking system, the front and rear suspensions are independently adjustable and offer enough reserves to keep the Specter under control in critical situations. All CARSON CY models are ball bearing mounted all round and have glued high-grip wheel-sets. The CARSON 2.4 GHz Reflex Wheel RC system is included with some models.





N° 500204035
1:8 CY Specter X V36 2.4 GHz RTR

500905082



Nitro-Set
Nitro Set

500905191



Nitro Treibstoff 16%
Nitro Fire Fuel 16%

500609042



Mignon-Set NiMH Akkus AA 1,2V (4)
Mignon-Set NiMH rechargeable batteries AA 1,2V (4)

500013312



Ladekabel BEC-Stecker
Charger cable BEC

500608104



Empfängerakku 1600 mAh
Receiver battery 1600 mAh

500606053



Expert Charger xBase 2.0 se
Expert Charger xBase 2.0 se

500205431

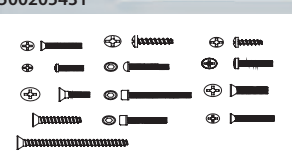

Schraubenset 1
Screwset 1

500205432

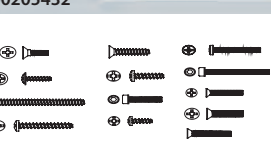

Schraubenset 2
Screwset 2

500205441

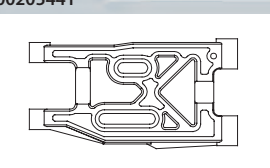

Querlenker hinten/unten
Rear lower suspension arm

500205438

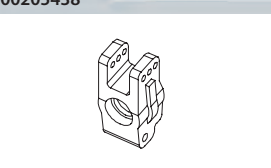

Achsschenkel Hinten
Rear Hub Carrier

500205449

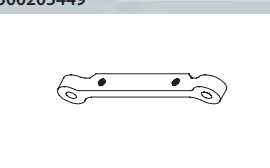

Querlenkerhalter vorne/oben
Front Upper Susp. Mount

500205455

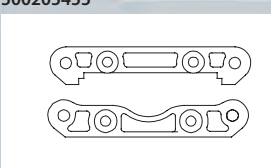

Querlenkerhalter vorne/unten
Front lower Susp. Mount

500205458

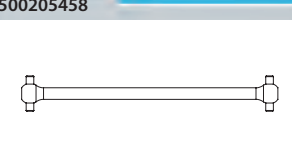

Antriebswelle hinten (2)
Rear Drive Shaft (2)

500205435

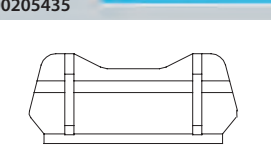

Frontrammer
Front Bumper

500205456

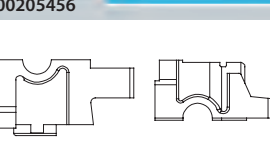

Getriebehöhle
Gear Box

500205464

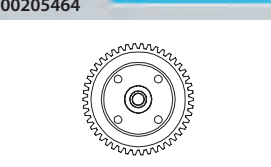

Hauptzahnrad 46T Stahl
Steel Spur Gear 46th

500205480

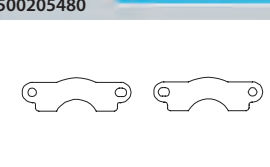

Bremsbeläge
Steel Brake Caliper

500205486

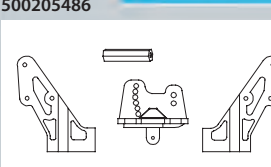

Spoilerhalterung
Wing mount posts

500205472

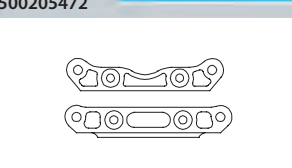

Querlenker hinten/unten
Rear lower suspension arm

500205473



Servosaver Teile
Steering Ball Cranks

500205490

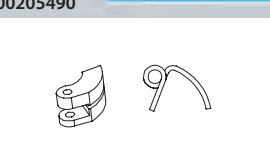

Kupplungsbacken / Federn
Clutch Shoes and Springs

500205493

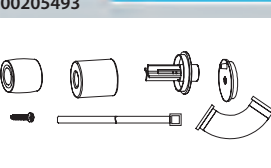

Luftfilter Set, schwarz
Air Filter Set, black

500205496

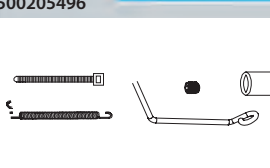

Resorohrbefestigungs-Set
Exhaust Set

500205498

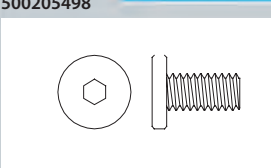

Motorschrauben (8)
Engine Screw (8)

500205599

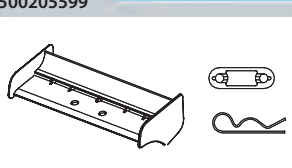

Spoilerset (weiß)
Rear Wing (White)

500205687

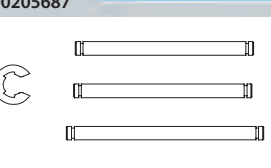

Querlenkerstifte u. Pins vorne
Hinge Pins and Clips

500205694



Motorhalter silber
Engine Mount Silver

500205701

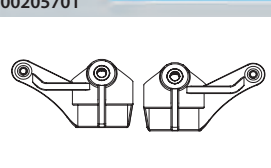

Achsschenkel L / R
Wheel Axle L / R

500205707

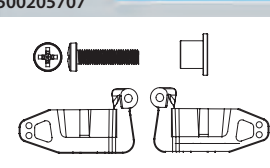

C-Hub vorne
C-Hub front

500902078



Silicon Dichtung für Reso.Rohr
Silicone Tube f. Exhaust Pipe

500205689

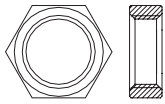

Radmutter Silber
Hex Wheel Nut Silver

500205708



Stoßdämpfer Vorne (2)
Front Shock (2)

500205703

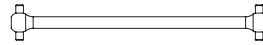

Antriebswelle V / H vorne (2)
Front Dog bone Center F / R (2)

500205706

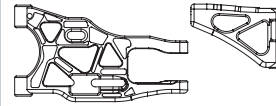

Querlenker Vorne
Front Suspension Arms

500205709



Stoßdämpfer Hinten (2)
Rear Shock (2)

500205437



Diff Innenteile
Diff Gears

500901013



Force Motor 36R / 5,9ccm SG-Welle
Force Motor 36R / 5.9ccm SG-Welle

500013117



Ladekabel für Glühkerzenstecker
Charging cable for glow plug igniter

500905061



Akku-/Glühkerzenstecker 230 V mit
integriertem 2500 mAh NIMH-Akku; 600 mA
Ladestrom / Battery/glow plug igniter set, 230 V

500905078



Tankfüllflasche 300 ml
Fuel bottle 300 ml

500054648



Force Seilzugstarter ohne Flansch
Pullstart

500905081



EMS-PRO Motor Start System
Starter Kit

500905011



Glühkerze Rossi R7
glowplug Rossi R7

500905065



Glühkerzenschlüssel
Wrench

500905071



Auspuff Chrom
Powerpipe chrom 1:8

500905193



Luftfilteröl 50 ml
Air Filter Oil

500905194



Afterrunöl 50 ml
After Run Oil

500905098



1:8 Pro Aluminium Luftfilter
1:8 Pro Aluminium airfilter

500905116



1:8 Luftfilter-Set
1:8 air filter set

500608024



Akku 7,2 V / 3500 mAh
Battery 7,2 V / 3500 mAh



| | | |
|---|-----------|---|
| 1 | 500205512 | CY-2 Stabilisator hinten / Rear Anti-Roll Kit, CY-2 Chassis |
| 2 | 500205513 | CY-2 Stabilisator vorne / Front Anti-Roll Kit, CY-2 Chassis |
| 3 | 500205716 | CY-2 Alu-Querlenker vorne / Front Lower Suspension Mount Alu CY-2 |
| 4 | 500205723 | CY-2 Alu-Querlenkerhalter / Rear Lower Susp.Mount Alum. CY-2 |
| 5 | 500205514 | CY-2 Tuning-Kardanwellen hinten / Tuning Drive Shaft, CY-2 Chassis rear |
| 6 | 500908047 | Radmuttern M12x1,25, 4 St. / WHEEL NUTS 4PCS. |
| 7 | 500205516 | CY-2 Dämpferstaubschutz / Dustproof Shock Absorber, CY-2 Chassis |



VIRUS NITRO-LINE

Die CARSON Virus-Line baut in ihrer neuesten Generation auf das bewährte Virus 4WD-Chassis auf. Die innovativen OffRoad Fahrzeuge beinhalten serienmäßig hochwertige Aluminiumteile wie die BigBore Öldruckstoßdämpfer, Dämpferbrücken und die Chassisplatte. Der Antriebsstrang besteht aus gehärtetem Stahl und bringt die Leistung der Force-Verbrennungsmotoren bestens auf die Piste und beschleunigt den Virus je nach Ausführung bis auf 90 km/h. Durch das 2-Scheiben Bremssystem ist die Vorder-Hinterachse separat einstellbar und bietet in kritischen Situationen genug Reserven um den Virus unter Kontrolle zu halten. Alle CARSON Virus-Modelle sind komplett Kugelgelagert und verfügen über verklebte HighGrip-Radsätze und nützliche Features wie Sideguards. Die Modellreihe bietet von ARR bis RTR stets den passenden Lieferumfang.

VIRUS NITRO-LINE

In its latest generation the CARSON Virus line builds upon the proven Virus 4WD chassis. The innovative off-road vehicles comprise high-grade aluminium parts such as big-bore oil-pressure shock absorbers, absorber bridges and a chassis plate as standard. The drive train is of hardened steel and delivers the Force combustion engine's output to the track optimally, accelerating some versions of the Virus up to 90 km/h. By virtue of the dual disk braking system, the front and rear suspensions are independently adjustable and offer enough reserves to keep the Virus under control in critical situations. All CARSON Virus models are ball bearing mounted all round and have glued high-grip wheel-sets and useful features such as sideguards. Whether ARR or RTR, the appropriate parts are always supplied with the series of models.

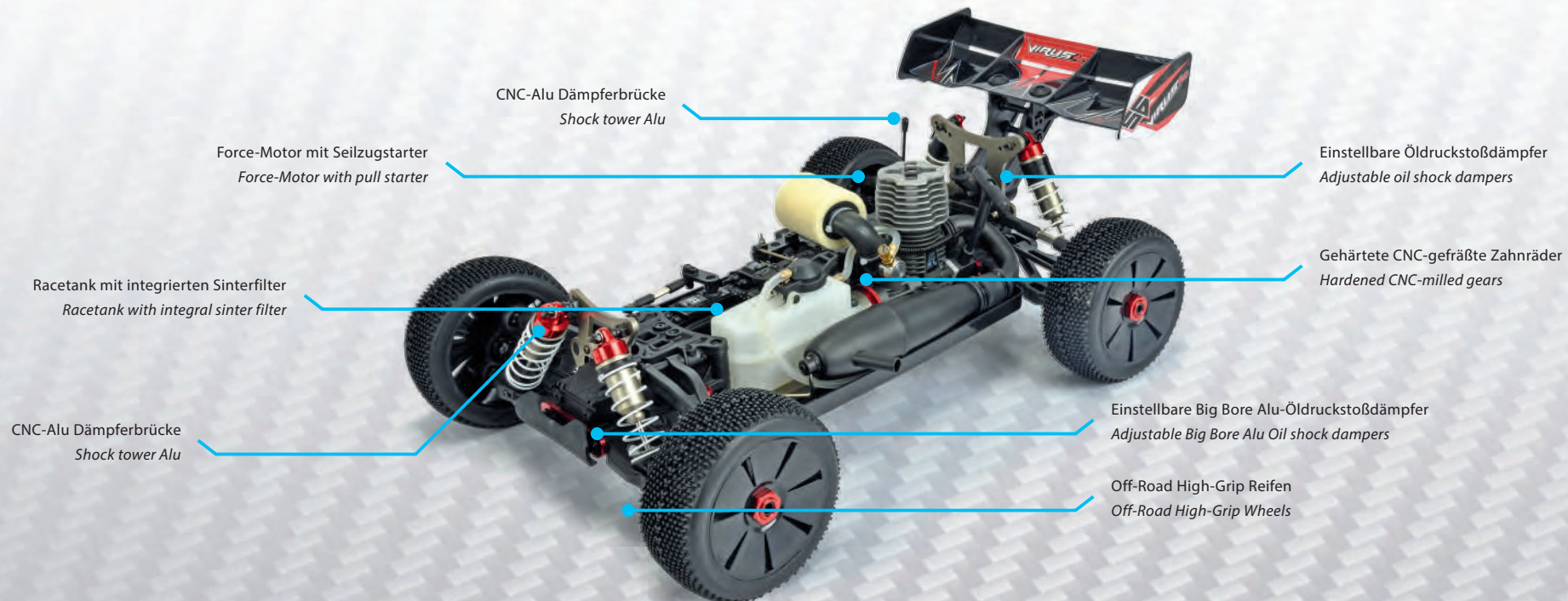

- 14+
- 4WD
- STOPP
- 2 Channel
- Federung
- 17 mm
- 1:8
- 65 km/h
- 3.460 g
- Force Engine
- 3.5 ccm
- 2.4 G
- 150 m
- 2x
- 9 kg
- 500 mm



N° 500204031
 1:8 Buggy Virus 4.0 V21 2.4 GHz RTR



N° 500204033
1:8 Virus 4.0 Pro V32 2.4 GHz RTR

500905082



Nitro-Set
Nitro Set

500905191



Nitro Treibstoff 16%
Nitro Fire Fuel 16%

500609042



Mignon-Set NiMH Akkus AA 1,2V (4)
Mignon-Set NiMH rechargeable batteries AA 1,2V (4)

500013312



Ladekabel BEC-Stecker
Charger cable BEC

500608104



Empfängerakku 1600 mAh
Receiver battery 1600 mAh

500606053



Expert Charger xBase 2.0 se
Expert Charger xBase 2.0 se

500205921



Mitteldiff komplett
Mitteldiff complete

500205924

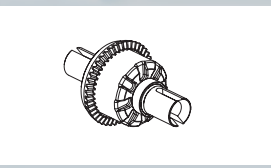

Diff vorne/hinten komplett
Diff front/rear complete

500205925



Kegelzahnrad/Mitnehmer
Bevelgear/joint cup

500205927

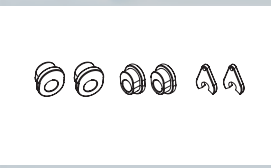

Querlenkeraufnahme
Lower arms support

500205928

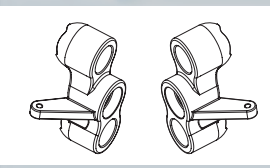

Lenkhebel vorne
Steering set

500205929

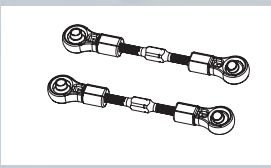

Lenkgestänge
Steering linkage

500205932

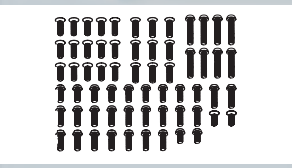

Schrauben-Set
Screw-kit

500205936

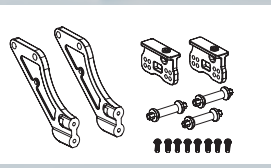

Spoilerhalter
Wing mount

500205937

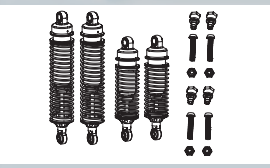

Alu Stoßdämpfer
Alu Shocks

500205938

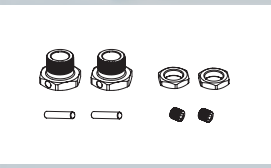

Alu-Felgenmitnehmer 17mm
Alu-hex hub 17mm

500205939

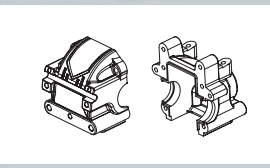

Getriebegehäuse
Gear housing

500205940

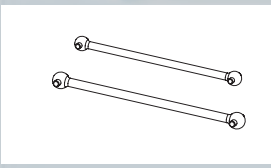

Mittelantriebswellen
Dog bone center

500205941

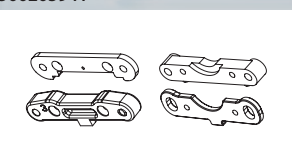

Querlenkerhalter-Set
Lower suspension mount-kit

500205942

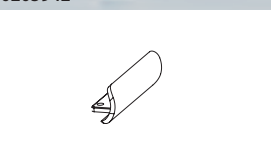

Frontrammer
Front bumper

500205943

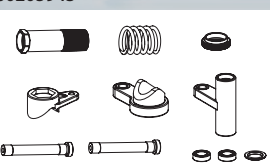

Servosaver-Einheit
Servosaver-Unit

500205945

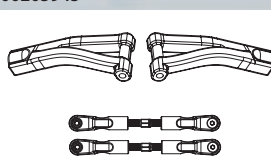

Querlenker-Set oben (4)
Upper front/rear tie-rod kit (4)

500205946

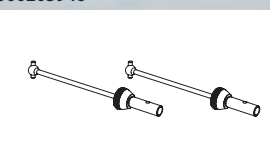

Kardanwellen vorne (2)
Front drive shafts (2)

500205947

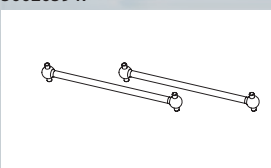

Antriebswellen hinten (2)
Dog bone rear (2)

500205948

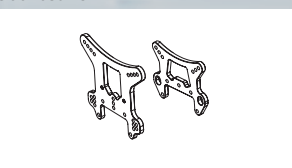

Dämpferbrücken v/h
Shock towers front/rear

500205949

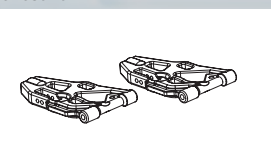

Querlenker-Set unten v. (2)
Lower Arms kit front (2)

500205950

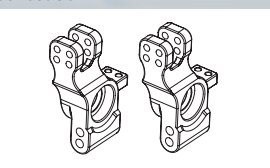

Achsschenkel hinten (2)
Rear hub carrier (2)

500205951



Karosseriehalter-Set
Bodyholder-Kit

500205956

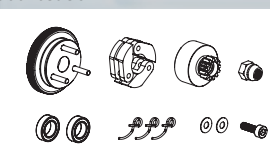

Kupplungsset komplett
Clutch-kit complete

500205957

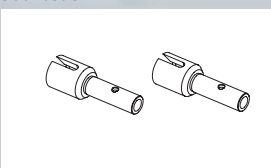

Achsen hinten
Axles rear

500205958

Querlenker-Set unten hi. (2)
Lower arms kit rear (2)

500205493

Luftfilter komplett
Airfilter complete 1:8

500905078

Tankfüllflasche 300 ml
Fuel bottle 300 ml

500054648

Force Seilzugstarter ohne Flansch
Pullstart

500905081

EMS-PRO Motor Start System
Starter Kit

500905011

Glühkerze Rossi R7 kalt
glowplug Rossi R7 cold

500905065

Glühkerzenschlüssel
Wrench

500013117

Ladekabel für Glühkerzenstecker
Charging cable for glow plug igniters

500905061

Akku-/Glühkerzenstecker set 230 V mit integriertem 2500 mAh NiMH-Akku; 600 mA Ladestrom / Battery/glow plug igniter set, 230 V

500905116

1:8 Luftfilter-Set
1:8 air filter set

500905193

Luftfilteröl 50 ml
Air Filter Oil

500905194

Afterrunöl 50 ml
After Run Oil

500905098

1:8 Pro Aluminium Luftfilter
1:8 Pro Aluminium airfilter

500905063

Akku-Glühkerzenstecker 2500 mAh NiMH
Battery glow plug igniter 2500 mAh NiMH

500905070

Auspuff Chrom
Power Pipe chrom 1:10

500906128

Micro Fail-Safe wasserdicht, Betriebsspannung 4,8-6 V, J/R-Servoanschlusskabel / Micro Fail-Safe water proof, Operating voltage 4,8-6 V

500905118

1:8 Luftfilter Schaumstoff
1:8 Airfilter foam

500908162

Corner Marker-Set NEON, Ø 13,5 cm (9 St.)
Corner Marker-Set, Ø 13,5 cm (9 Pc.)

500908181

Montagestander f.1:10/1:8(Aluminium)
Car stand 1:10/1:8 (Aluminium)

500908133

Transporttasche
Car Bag TAMIYA Fighter

500908062

Karosserieklammern 27 mm 1:8 Modelle je 10 Stück / body braces 27 mm 1:8 Models à 10 pieces

500503028

Ladekabel Tamiya
Charging cable Tamiya

500608077

Racing Pack 7,2 V/4500 mAh NiMH
Tamiya-Stecker / Tamiya connector

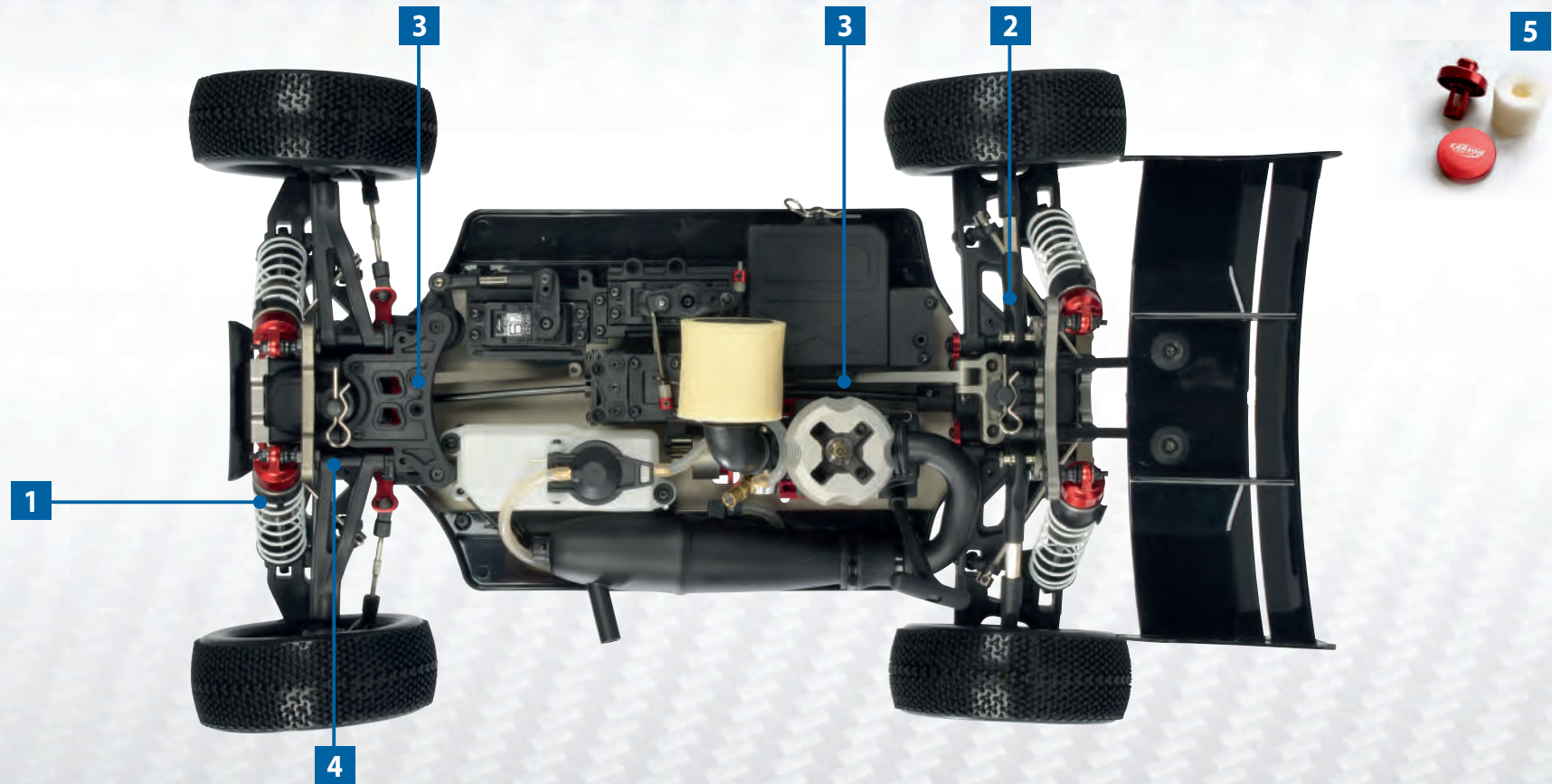

| | | | |
|---|-----------|---|-------|
| 1 | 500205963 | Stabilisator-Satz vorn Virus 4.0 / Virus 4.0 Front Sway Bar Kit | EP/GP |
| 2 | 500205964 | Stabilisator-Satz hinten Virus 4.0 / Virus 4.0 Rear Sway Bar Kit | EP/GP |
| 3 | 500205965 | Alu Chassis-Versteifung vo/hi. Virus 4.0 / Virus 4.0 Chassis Brace Set front/rear | EP/GP |
| 4 | 500205971 | Alu Halter Querlenker vorn (1) Virus 4.0 / Virus 4.0 Front Toe in Plate | EP/GP |
| 5 | 500905098 | 1:8 Pro Aluminium Luftfilter / 1:8 Pro Aluminium airfilter | EP/GP |



N° 500304032

1:5 Wild GP Attack 2.4 GHz RTR



Premium-Line



RAUPENBAGGER
 89

MULDENKIPPER
 90



SEILBAGGER
 91

2.4 GHz IM "USED LOOK"

Die CARSON Premiumline Baufahrzeuge in verschiedenen Maßstäben beinhaltet viele detaillierte Modelle mit neuester Technik und 2.4 GHz Mehrkanalfernsteuerung sowie vielen Funktionen wie Licht, Schüttgut und je nach Ausführung über den Sender steuerbare Baufunktionen. Die ganze Serie ist mit Sender, Fahraku, Ladegerät und Anleitung voll ausgestattet und nach dem Laden sofort startbereit. Kaufen, laden - fahren!

2.4 GHz IN USED LOOK

The CARSON Premium line construction vehicles at different scales includes many detailed models with the latest technology and a 2.4 GHz multi-channel RC system and many functions such as light, bulk material and model-dependent construction functions controllable via the transmitter. The entire series is fully equipped with a transmitter, rechargeable driving battery, charger and instructions and once charged up is immediately ready to go. Purchase, charge – drive!



N° 500907332
1:16 Raupenbagger 15 Kanal 2.4 GHz RTR

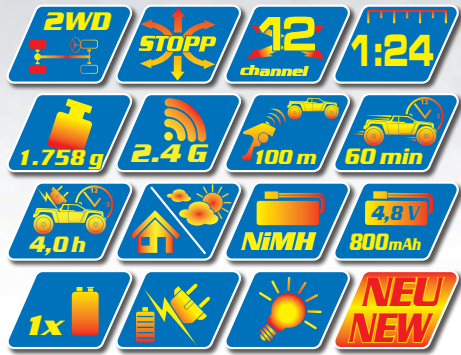

N° 500907193
1:24 Muldenkipper 2.4 GHz 100% RTR



N° 500907191
1:12 Seilbagger 2.4 GHz 100% RTR



Panzer-Line



M1A1 ABRAMS

97

LEOPARD 2A5

95



LEOPARD 2A6 WINTER CAMOUFLAGE

96



Mit Einzelschussfunktion / with single gunshot function

RC PANZER MIT VIELEN DETAILS

Die Hobby Engine Panzer aus der Junior Line sind absolut vorbildgetreu und voll funktionsfähig aufgebaut. Sogar Sound und Licht werden simuliert. Mit der Schussfunktion können die mitgelieferten Projektile bis zu 1 Meter weit abgefeuert werden. Dank der aufwendigen Lackierung sehen die Panzer im Maßstab 1:16 aus, als kämen sie direkt vom Truppenübungsplatz. Kräftige Elektromotoren bewältigen Steigungen bis 30°, drehen den Geschützturm, senken und heben das Hauptrohr oder erlauben die Drehung auf der Stelle. Alle Funktionen des 100% komplett ausgestatteten Panzers werden per 27 MHz RC-Anlage ferngesteuert. Kaufen, laden - fahren!

FULL FEATURED RC TANKS

The Hobby Engine tanks from the Junior line are true-to-the-original fully working models. Even sound and light are simulated. With the fire function the projectiles included in the delivery can be fired off to a distance of up to 1 metre. Thanks to the lavish paint finish, the 1:16 scale tanks look like they might have come straight from the military training ground. Powerful electric motors overcome inclines of up to 30°, rotate the gun turret, lower and raise the main barrel or allow on-the-spot rotation. All functions of the 100% equipped tank are remotely controlled via the 27 MHz RC system. Purchase, charge – drive!





N° 500907189
1:16 Leopard 2A6 2.4 GHz 100% RTR





N° 500907196
1:16 Leopard 2A6 Winterarn 2.4 GHz 100% RTR / winter camouflage



500608129



Ersatzakku 7,2V/800mAh
Optional Battery

N° 500907187

1:16 M1 A1 Abrams 2.4 GHz 100% RTR



TRUCK MULTIFUNCTION



Truck Multifunction-Line

LINDE FORKLIFT

101



LINDE FORKLIFT

102



MB UNIMOG U300 FEUERWEHR

104



MB UNIMOG U300 THW

105



MB UNIMOG U300

103

FERNGESTEUERTE ALLESKÖNNER

Die CARSON Funktionsmodelle aus der 6-Kanal-Linie sind hochdetailliert und stehen in Aussehen und Funktion ihren großen Vorbildern in nichts nach. Sonderfunktionen wie Seilwinde, Front-Hecklichter, Hupe, Rundumlicht, Kipp-Senkfunktion der Ladefläche, Seilwinde, ein- und auskuppeln sowie heben und senken des Ladebaums werden über die mitgelieferte CARSON ReflexStick 2,4 Ghz 6-Kanal Fernsteuerung separat angesteuert. Anbeileile wie das Winterkit runden die Funktionen der Unimogs ab und machen diese zu einem einsatzfähigen Winterdienst. Durch den kompletten Lieferumfang mit Sender, Senderbatterien, Fahrakku mit Ladegerät oder Fahrbatterien und Anleitung sind die Funktionsfahrzeuge nach dem Laden gleich einsatzbereit. Kaufen, laden - fahren!

REMOTE CONTROLLED ALLROUNDER

The CARSON functional models of the 6 channel line are highly detailed and in no way inferior to their full-size counterparts in appearance and functioning. Special functions such as the rope winch, front and rear lights, horn, all-round light, loading area tilt and lower function, winch engagement and disengagement as well as raising and lowering the loading tree are controlled separately via the included CARSON Reflex Stick 2.4 GHz 6-channel RC system. Accompanying parts such as the winter kit round off the functions of the Unimog and make it a deployable winter service vehicle. Since the functional vehicles come as a complete package with the transmitter and its batteries, rechargeable driving battery with charger or driving batteries and instructions, once they have been charge they are ready to run. Purchase, charge – drive!

Hightech Präzisionsstapler

Der CARSON-MODEL SPORT Gabelstapler Linde H 40 D ist ein voll funktionsfähiges RC-Modell, das jeden Truck-Fuhrpark perfekt ergänzt. Ferngesteuert wird der Stapler im Maßstab 1:14 per 6-Kanal 2,4 GHz Pultsender, den sich der Fahrer mit einem komfortablen Tragegurt umhängen kann. Neben den vielen Fahrfunktionen verfügt das Fertigmodell über einen funktionstüchtigen Gabelbaum sowie ein Licht- und Soundmodul.

Technische Daten: Antrieb per Elektromotor.

High tech precision fork lift

The CARSON-MODEL SPORT Fork Lift Linde H 40 D is a completely functional RC model and an exceptional supplement to every truck fleet. The scale 1:14 fork lift is remote controlled via a 6-channel 2.4 GHz console transmitter that can be comfortably draped around the driver's via a carrying strap. In addition to the many driving functions, the complete model features a functional wishbone boom and a light and sound module.

Technical data: Electric drive.

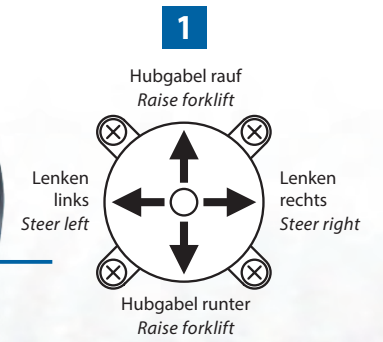
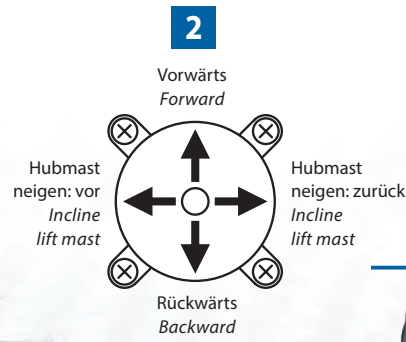

200 g Hubkraft / 200 g lifting power

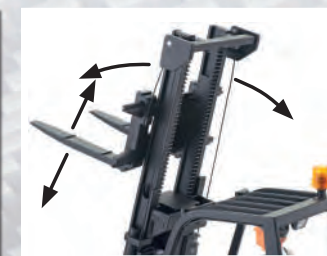

Voll steuerbarer Hubmast / Fully controllable lift mast



Inkl. Fahrerpuppe / Incl. driver figure



N° 500907343

1:14 Linde Gabelstapler Orange 2.4 GHz 100% RTR / 1:14 Linde Forklift orange 2.4 GHz 100% RTR



N° 500907093

1:14 Linde Gabelstapler 2.4 GHz 100% RTR / 1:14 Linde Forklift 2.4 GHz 100% RTR



TRUCK MULTIFUNCTION

N° 500907720

1:12 Mercedes-Benz Unimog U300 Orange 2.4 GHz 100% RTR



N° 500907721

1:12 Mercedes-Benz Unimog U300 Feuerwehr 2.4 GHz 100% RTR



TRUCK MULTIFUNCTION

N° 500907722

1:12 Mercedes-Benz Unimog U300 THW 2.4 GHz 100% RTR



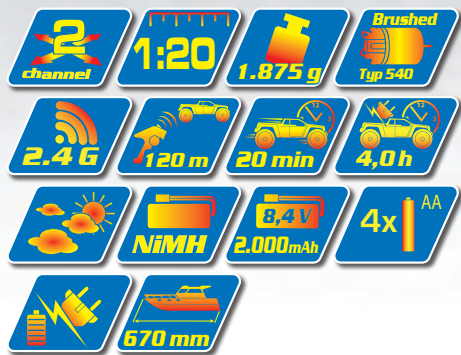

N° 500108007

1:20 RC-Motoryacht Saint Princess 2.4 GHz 100%RTR

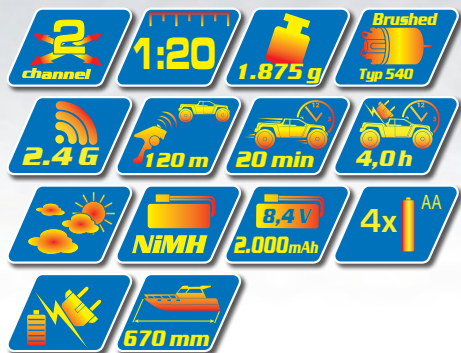

N° 500108013
1:20 Motoryacht Sunset 2.4 GHz 100%RTR





Wasser marsch! Werde Kapitän des Feuerlöschbootes!

Das coole CARSON Feuerwehrboot ist voll funktionsfähig und hat sogar eine echte und fernsteuerbare Wasserkanone. Der Lieferumfang ist 100 %-ig komplett und beinhaltet neben dem Feuerlöschboot mit Sender auch Senderbatterien und einen Fahrakku mit Ladegerät.

Technische Daten: 2.4 GHz 3-Kanal RC-System mit 4 proportionalen und 1 Schaltkanal • Steuerbare Funktionen: vorwärts/rückwärts, links/rechts, Wasserspritzfunktion.

Time for water antics! Become captain of the fire boat!

The cool CARSON fire boat is fully functioning and even has a real, remote-controlled, water cannon. The fire boat is supplied as standard with everything you need, including the transmitter with batteries and a drive battery with charger.

Technical data: 2.4 GHz 3-channel RC system with 4 proportional and 1 switching channel • Control functions: forwards/backwards, left/right, water squirting function.



N° 500108033
RC-Feuerlöschboot TC-08 2.4 GHz 100% RTR



Ahoi Kapitän - Werde Steuermann auf dem Fischkutter!

Der CARSON Fischkutter CUX-13 ist ein voll funktionsfähiges RC-Modell eines typischen Nordseefischkutters. Wie beim Original lassen sich die Fangnetze auslegen und einholen, das sogar per Fernsteuerung. Neben den Fahrfunktionen hat der Kutter ein Soundmodul für den originalen Motorsound und ein fernbedienbares Nebelhorn. Mit der 2.4 GHz-Fernsteuerung lassen sich Suchscheinwerfer und Kabinenbeleuchtung ein- und ausschalten. Der Lieferumfang ist 100 %-ig komplett und beinhaltet Bootsmodell mit Sender, Senderbatterien und einen NiMH-Fahrakku mit Ladegerät.

Technische Daten: 2.4 GHz 6-Kanal RC-System mit 4 proportionalen und 2 Schaltkanälen • Steuerbare Funktionen: vorwärts/rückwärts, links/rechts, Fischernetz, Nebelhorn, Beleuchtung.

Ahoy skipper – become a steersman on the fishing cutter!

The CUX-13 CARSON fishing cutter is a fully functional RC model of a typical North Sea fishing cutter. You can cast out and bring the net back in like with the original, even remote controlled. On top of the driving functions the cutter has a remote controlled fog horn as well as a sound module for authentic engine sound. With the 2.4 GHz remote control, search headlights and cabin illumination can be switched on and off. The scope of delivery is 100 % complete and includes the boat model with radio transmitter, transmitter batteries and a NiMH drive battery with recharger.

Technical data: 2.4 GHz 6-channel RC system with 4 proportional and 2 switching channels • Control functions: forwards/backwards, left/right, fishing net function, foghorn, lights. plug-in charger with 500 mA charging current.



N° 500108031

RC Fischkutter / RC Fishing Cutter "CUX-15" 2.4 GHz 100%RTR





Wasser marsch! Werde Kapitän des Küstenwachbootes!

Das coole CARSON Küstenwachboot ist voll funktionsfähig und hat sogar eine echte und fernsteuerbare Wasserkanone. Zusätzlich zu den Fahrfunktionen hat das Boot ein Soundmodul für den original Motorsound und ein fernbedienbares Nebelhorn. Mit der 2.4 GHz-Fernsteuerung lassen sich auch der Suchscheinwerfer ein- und ausschalten. Der Lieferumfang ist 100 %-ig komplett und beinhaltet neben dem Küstenwachboot mit Sender auch Senderbatterien und einen Fahrakku mit Ladegerät.

Technische Daten: 2.4 GHz 6-Kanal RC-System mit 4 proportionalen und 2 Schaltkanälen • Steuerbare Funktionen: vorwärts/rückwärts, links/rechts, Beleuchtung.

Time for water antics! Become captain of the coastguard boat!

The cool CARSON coastguard boat is fully functioning and even has a real, remote-controlled, water canon. In addition to the driving functions, the boat has a sound module for authentic engine noises and a remote-controlled foghorn. The searchlights can also be switched on and off using the 2.4 GHz remote control. The coastguard boat is supplied as standard with everything you need, including the transmitter with batteries and a drive battery with charger.

Technical data: 2.4 GHz 6-channel RC system with 4 proportional and 2 switching channels • Control functions: forwards/backwards, left/right, lights.



N° 500108032

RC-Küstenwache / Coastguard "TC-08" 2.4 GHz 100% RTR





- 3 Kanal Empfänger / 3 channel receiver
- Integriertes / Integrated Failsafe
- TAMIYA KIT comatible

Lieferumfang: 3-Kanal 2,4 GHz Fernsteueranlage, 3-Kanal Mini-Empfänger und Anleitung.

Scope of delivery: 3 channel 2.4 GHz RC system, 3-channel receiver and manual.



**N° 500501543 Reflex
Wheel Start 2.4 GHz
Empfänger**

N° 500500100 (Blaue Version)

N° 500500102 (Schwarze Version)

N° 500500104 (Türkise Version)

Reflex Wheel Start 2.4 GHz Radio

N° 500500100 blue

N° 500500102 black

N° 500500104 turquoise



Technische Daten: Betriebsspannung Sender 4,8 bis 6 V • zwei stufenlos regelbare vollproportionale Kanäle • Servo-Reverse für beide Kanäle (Umkehrung der Laufrichtung) • Trimmfunktion für Gas und Lenkung • Dual Rate für beide Kanäle (Wegbegrenzung der Servos) • Stromversorgung des Empfängers (ohne BEC) bis 11V möglich • Integriertes Fail-Safe • Uni-Steckersystem für Futaba und Graupner-J/R • Batteriezustandsanzeige mittels LED.

Technical Data: Operating Voltage of transmitter 4,8 up to 6 V • two continuously controllable fully proportional channels • servo reverse for both channels (reversal of the running direction) • trimming function for accelerator and steering • Dual Rate for both channels (path limitation of the servos) • powering of receiver (without BEC) 11 V possible • Integrated Fail-Safe • plug system for Futaba and Graupner-J/R • battery status indicator by LED.



Technische Daten: Betriebsspannung Sender 4,8 bis 6V • Betrieb mit 4x AA NiMh Zellen • 2,4 GHz FHSS-System (Frequenz Hopping Spread Spectrum) • zwei stufenlos regelbare vollproportionale Kanäle • Servo-Reverse für beide Kanäle (Umkehrung der Laufrichtung) • Trimmfunktion für Gas und Lenkung • Dual Rate für beide Kanäle (Wegbegrenzung der Servos) • Stromversorgung des Empfängers (ohne BEC) ist bis 11,1V möglich • Integriertes Fail-Safe (programmierbar) • Uni-Steckersystem für Futaba und Graupner-J/R • Ladebuchse (Pluspol innen) • Batteriezustandsanzeige mittels LED.

Technical Data: Operating Voltage 4,8 bis 6 V • Operation with 4x AA NiMh batteries • 2,4 GHz FHSS-System (Frequenz Hopping Spread Spectrum) • two continuously controllable fully proportional channels • servo reverse for both channels (reversal of the running direction) • trimming function for accelerator and steering • Dual Rate for both channels (path limitation of the servos) • powering of receiver (without BEC) up to 11,1 V possible • Integrated Fail-Safe (programmable) • plug system for Futaba and Graupner-J/R • charging socket (plus terminal inside) • battery status indicator by LED.

N° 500500052

Reflex Wheel PRO 3 2.4 GHz



Kugelgelagerte Steuereinheit für präziseres Lenken / Ball beared control unit for precise steering



Kontrolleinheit ergonomisch einstellbar. / Control unit ergonomic adjustable.



Blau beleuchtete Betriebsanzeige / blue illuminated operation indicator.



Betrieb mittels AA-Batterien oder optionalen LiPo Akku / Operation with AA-batteries or optional LiPo accumulator.

Lieferumfang: 2-Kanal, 2,4 GHz Sender, Mini-Empfänger, Mehrsprachiges Handbuch.

Scope of delivery: 2 Channel, 2,4 GHz transmitter, mini receiver, manual in several languages.



Technische Daten: Betriebsspannung Sender 4,8 bis 6V • Betrieb mit 4x AA NiMh Zellen • 2,4 GHz FHSS-System (Frequenz Hopping Spread Spectrum) • zwei stufenlos regelbare vollproportionale Kanäle • Servo-Reverse für beide Kanäle (Umkehrung der Laufrichtung) • Trimmfunktion für Gas und Lenkung • Dual Rate für beide Kanäle (Wegbegrenzung der Servos) • Stromversorgung des BEC-Empfängers über einen Fahrakku mit 4,8-7,2V möglich • Integriertes Fail-Safe (programmierbar) • Uni-Steckersystem für Futaba und Graupner-J/R • Ladebuchse (Pluspol innen) • Batteriezustandsanzeige mittels LED.

Technical Data: Operating Voltage 4,8 bis 6 V • Operation with 4x AA NiMh batteries • 2,4 GHz FHSS-System (Frequenz Hopping Spread Spectrum) • two continuously controllable fully proportional channels • servo reverse for both channels (reversal of the running direction) • trimming function for accelerator and steering • Dual Rate for both channels (path limitation of the servos) • powering of BEC-receiver with drive battery from 4,8V to 7,2 V possible • Integrated Fail-Safe (programmable) • plug system for Futaba and Graupner-J/R • charging socket (plus terminal inside) • battery status indicator by LED.

N° 500500053

Reflex Wheel PRO3 2.4 GHz BEC



Kugelgelagerte Steuereinheit für präziseres Lenken / Ball beared control unit for precise steering



Kontrolleinheit ergonomisch einstellbar. / Control unit ergonomic adjustable.



Blau beleuchtete Betriebsanzeige / blue illuminated operation indicator.



Betrieb mittels AA-Batterien oder optionalen LiPo Akku / Operation with AA-batteries or optional LiPo accumulator.

Lieferumfang: 2-Kanal, 2,4 GHz Sender, Mini-Empfänger, Mehrsprachiges Handbuch.

Scope of delivery: 2 Channel, 2,4 GHz transmitter, mini receiver, manual in several languages.

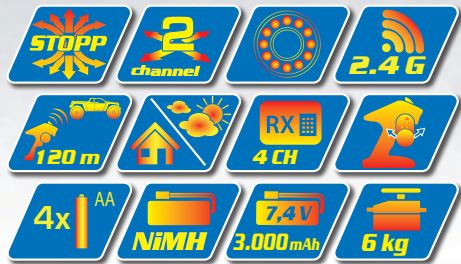

Perfekt geeignet für alle 1:10 TAMIYA-Bausätze und ist ein optimales Ergänzungssset zu einem ARR Automodell. Das Ladegerät lädt den 7,2V/3000mAh Fahrakku mit einem Ladestrom von 2A. Die Abschaltung des Ladevorgangs erfolgt automatisch mittels Delta Peak-Schaltung. Die vier Senderakkus können gleichzeitig mit einem Ladestrom von 500 mA geladen werden.

This Electro Set is perfect for all TAMIYA Kits and completes every ARR car model. The charger will charge the 7.2V/3000mAh battery with a current of 2A. It includes Delta Peak function for automatic cut-off. The four transmitter batteries can be charged at the same time with a charging current of 500 mA.

N° 500500091
RC-Reflex Pro 3 Elektro Set



Empfohlen für TAMIYA Bausätze / Recommended for TAMIYA kits

Lieferumfang: Reflex Wheel 3 Pro 2.4 G mit Empfänger und CS-6 Servo mit Metallgetriebe, Fahrakku 7,2V/3000 mAh, 4 AA-Mignon 2100 mAh Akkus für den Sender, Expert Charger mit 2A/500 mA inkl. Ladeschale.
Scope of delivery: 2.4 G Reflex Wheel 3 Pro remote control unit with receiver and CS-6 servo with metal gear, 7.2V/3000 mAh drive battery, 4x AA-Mignon batteries 2100 mAh for the transmitter, Expert Charger with 2A/500 mA incl. battery charging box.

Ersatz & Optionale Teile / Spare & Option Parts

500501533

Empfänger Reflex Wheel PRO3 2.4 GHz
Receiver Reflex Wheel PRO3 2.4 GHz

500501534

Empfänger / Receiver Reflex Wheel PRO3 2.4 GHz waterresistant

500501535

Empfänger Reflex Wheel PRO3 2.4 GHz BEC
Receiver Reflex Wheel PRO3 2.4 GHz BEC

500501536

Empfänger / Receiver Reflex Wheel PRO3 2.4 GHz BEC waterresistant

500609042

Mignon Set NiMH Akku 1,2 V / 2100 mAh

500906128

Micro-Fail Safe wasserdicht
Micro-Fail Safe waterproof

500608104

Akkupack Empfänger 6V/1600 mAh NiMH.
Mit BEC-Steckersystem. / The pack consists of 2/3AA cells. With BEC connector system.

500501538

Empfänger Reflex Wheel PRO3 Nano RX 2.4 GHz / Receiver Reflex Wheel PRO3 Nano RX 2.4 GHz



Technische Daten: Betriebsspannung Sender 4,8 bis 6 V • Betrieb mit 4x AA NiMH Zellen • 2.4 GHz FHSS-System (Frequenz Hopping Spread Spectrum) • zwei stufenlos regelbare vollproportionale Kanäle • ein zusätzlicher Schaltkanal für Sonderfunktionen • Servo-Reverse für alle Kanäle (Umkehrung der Laufrichtung) • Trimmfunktion für Gas und Lenkung • Dual Rate für Gas und Lenkung (Wegbegrenzung der Servos) • EPA (Servowegbegrenzung) für Gas und Lenkung • ABS-Funktion = Stotterbremse (Servo macht auf und zu) für Gas-Servo • EXPO-Funktion für Gas und Lenkung (Exponential) • Stromversorgung des Empfängers (ohne BEC) ist bis 11,1V möglich • Integriertes Fail-Safe (programmierbar) • Uni-Steckersystem für Futaba und Graupner-J/R • Ladebuchse (Pluspol innen)

Technical Data: Operating Voltage 4,8 bis 6 V • Operation with 4x AA NiMH batteries • 2.4 GHz FHSS-System (Frequenz Hopping Spread Spectrum) • two continuously controllable fully proportional channels • additional channel for special function • servo reverse for both channels (reversal of the running direction) • trimming function for accelerator and steering • Dual Rate for both channels (path limitation of the servos) • EPA (path limitation of servos) for acceleration and steering • ABS function = intermittent brake (servo opens and closes) for throttle servo • EXPO function for throttle and steering (exponential) • powering of receiver (without BEC) up to 11,1 V possible • Integrated Fail-Safe (programmable) • plug system for Futaba and Graupner-J/R • charging socket (plus terminal inside).

N° 500500054

Reflex Wheel PRO 3 2.4 GHz LCD



15 Modellspeicher



Kugelgelagerte Steuereinheit für präziseres Lenken / Ball beared control unit for precise steering



Kontrolleinheit ergonomisch einstellbar. / Control unit ergonomic adjustable.



Blau beleuchtete Betriebsanzeige / blue illuminated operation indicator.



Betrieb mittels AA-Batterien oder optionalen LiPo Akku / Operation with AA-batteries or optional LiPo accumulator.

Lieferumfang: 3-Kanal, 2.4 GHz LCD Sender, Mini-Empfänger, Mehrsprachiges Handbuch.

Scope of delivery: 3 Channel, 2.4 GHz LCD transmitter, mini receiver, manual in several languages.



Technische Daten: Betriebsspannung Sender 4,8 bis 6 V • Betrieb mit 4x AA NiMH Zellen • 2.4 GHz FHSS-System (Frequenz Hopping Spread Spectrum) • zwei stufenlos regelbare vollproportionale Kanäle • ein zusätzlicher Schaltkanal für Sonderfunktionen • Servo-Reverse für alle Kanäle (Umkehrung der Laufrichtung) • Trimmfunktion für Gas und Lenkung • Dual Rate für Gas und Lenkung (Wegbegrenzung der Servos) • EPA (Servowegbegrenzung) für Gas und Lenkung • ABS-Funktion = Stotterbremse (Servo macht auf und zu) für Gas-Servo • EXPO-Funktion für Gas und Lenkung (Exponential) • Stromversorgung des BEC-Empfängers über einen Fahrakku mit 4,8-7,2V möglich • Integriertes Fail-Safe (programmierbar) • Uni-Steckersystem für Futaba und Graupner-J/R • Ladebuchse (Pluspol innen)

Technical Data: Operating Voltage 4,8 bis 6 V • Operation with 4x AA NiMH batteries • 2.4 GHz FHSS-System (Frequenz Hopping Spread Spectrum) • two continuously controllable fully proportional channels • additional channel for special function • servo reverse for both channels (reversal of the running direction) • trimming function for accelerator and steering • Dual Rate for both channels (path limitation of the servos) • EPA (path limitation of servos) for acceleration and steering • ABS function = intermittent brake (servo opens and closes) for throttle servo • EXPO function for throttle and steering (exponential) • powering of BEC-receiver with drive battery from 4.8 V to 7.2 V possible • Integrated Fail-Safe (programmable) • plug system for Futaba and Graupner-J/R • charging socket (plus terminal inside).

N° 500500055

Reflex Wheel PRO3 2.4 GHz LCD BEC



15 Modellspeicher



Kugelgelagerte Steuereinheit für präziseres Lenken / Ball beared control unit for precise steering



Kontrolleinheit ergonomisch einstellbar. / Control unit ergonomic adjustable.



Blau beleuchtete Betriebsanzeige / blue illuminated operation indicator.



Betrieb mittels AA-Batterien oder optionalen LiPo Akku / Operation with AA-batteries or optional LiPo accumulator.

Lieferumfang: 3-Kanal, 2.4 GHz LCD Sender, Mini-Empfänger, Mehrsprachiges Handbuch.

Scope of delivery: 3 Channel, 2.4 GHz LCD transmitter, mini receiver, manual in several languages.

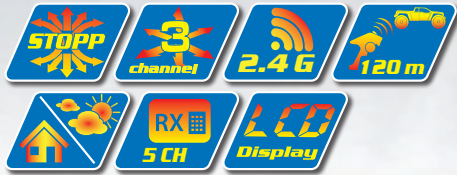

Hervorragend für den Einsatz in Schiffen und Booten, sowie für extremen RC-Car Einsatz geeignet! / Perfect for use in ships and boats and also for use with extreme RC cars!

Technische Daten: Betriebsspannung Sender 4,8 bis 6 V • Betrieb mit 4x AA NiMH Zellen • 2,4 GHz FHSS-System (Frequenz Hopping Spread Spectrum) • zwei stufenlos regelbare vollproportionale Kanäle • ein zusätzlicher Schaltkanal für Sonderfunktionen • Servo-Reverse für alle Kanäle (Umkehrung der Laufrichtung) • Trimmfunktion für Gas und Lenkung • Dual Rate für Gas und Lenkung (Wegbegrenzung der Servos) • EPA (Servowegbegrenzung) für Gas und Lenkung • ABS-Funktion = Stotterbremse (Servo macht auf und zu) für Gas-Servo • EXPO-Funktion für Gas und Lenkung (Exponential) • Stromversorgung des BEC-Empfängers über einen Fahrakku mit 4,8-7,2V möglich • Integriertes Fail-Safe (programmierbar) • Uni-Steckersystem für Futaba und Graupner-J/R • Ladebuchse (Pluspol innen)

Technical Data: Operating Voltage 4,8 bis 6 V • Operation with 4x AA NiMH batteries • 2,4 GHz FHSS-System (Frequenz Hopping Spread Spectrum) • two continuously controllable fully proportional channels • additional channel for special function • servo reverse for both channels (reversal of the running direction) • trimming function for accelerator and steering • Dual Rate for both channels (path limitation of the servos) • EPA (path limitation of servos) for acceleration and steering • ABS function = intermittent brake (servo opens and closes) for throttle servo • EXPO function for throttle and steering (exponential) • powering of BEC-receiver with drive battery from 4.8 V to 7.2 V possible • Integrated Fail-Safe (programmable) • plus system for Futaba and Graupner-J/R • charging socket (plus terminal inside).

N° 500500056
Reflex Wheel PRO 3 2.4 GHz BEC "Marine"



Kugelgelagerte Steuereinheit für präziseres Lenken / Ball beared control unit for precise steering



Kontrolleinheit ergonomisch einstellbar. / Control unit ergonomic adjustable.



Blau beleuchtete Betriebsanzeige / blue illuminated operation indicator.



Betrieb mittels AA-Batterien oder optionalen LiPo Akku / Operation with AA-batteries or optional LiPo accumulator.

Lieferumfang: 3-Kanal, 2,4 GHz LCD Sender, wasserfester Mini-Empfänger, wasserfestes 6 kg Servo, Mehrsprachiges Handbuch.
Scope of delivery: 3 Channel, 2,4 GHz LCD transmitter, waterresistant mini receiver, waterresistant 6 kg servo, manual in several languages.

Ersatz & Optionale Teile / Spare & Option Parts

500501533

Empfänger Reflex Wheel PRO3 2.4 GHz
Receiver Reflex Wheel PRO3 2.4 GHz

500501534

Empfänger / Receiver Reflex Wheel PRO3 2.4 GHz waterresistant

500501535

Empfänger Reflex Wheel PRO3 2.4 GHz BEC
Receiver Reflex Wheel PRO3 2.4 GHz BEC

500501536

Empfänger / Receiver Reflex Wheel PRO3 2.4 GHz BEC waterresistant

500609042

Mignon Set NiMH Akku 1,2V / 2100 mAh

500906128

Micro-Fail Safe wasserdicht
Micro-Fail Safe waterproof

500608104

Akkupack Empfänger 6V/1600 mAh NiMH.
Mit BEC-Steckersystem. / The pack consists of 2/3AA cells. With BEC connector system.

500501538

Empfänger Reflex Wheel PRO3 Nano RX 2.4 GHz
Receiver Reflex Wheel PRO3 Nano RX 2.4 GHz



Technische Daten: Betriebsspannung Sender 4,8 bis 6V • Betrieb mit 4x AA NiMh Zellen • 2,4 GHz FHSS-System (Frequenz Hopping Spread Spectrum) • zwei stufenlos regelbare vollproportionale Kanäle • Servo-Reverse für beide Kanäle (Umkehrung der Laufrichtung) • Trimmfunktion für Gas und Lenkung • Dual Rate für beide Kanäle (Wegbegrenzung der Servos) • Stromversorgung des Empfängers (ohne BEC) ist bis 11,1V möglich • Integriertes Fail-Safe (programmierbar) • Uni-Steckersystem für Futaba und Graupner-J/R • Ladebuchse (Pluspol innen) • Batteriezustandsanzeige mittels LED.

Technical Data: Operating Voltage 4,8 bis 6 V • Operation with 4x AA NiMh batteries • 2,4 GHz FHSS-System (Frequenz Hopping Spread Spectrum) • two continuously controllable fully proportional channels • servo reverse for both channels (reversal of the running direction) • trimming function for accelerator and steering • Dual Rate for both channels (path limitation of the servos) • powering of receiver (without BEC) up to 11,1 V possible • Integrated Fail-Safe (programmable) • plug system for Futaba and Graupner-J/R • charging socket (plus terminal inside) • battery status indicator by LED.

N° 500500148

Reflex Wheel X1 2.4 GHz



Lieferumfang: 2-Kanal, 2,4 GHz Sender, Mini-Empfänger, Mehrsprachiges Handbuch.

Scope of delivery: 2 Channel, 2,4 GHz transmitter, mini receiver, manual in several languages.



Technische Daten: Betriebsspannung Sender 4,8 bis 6V • Betrieb mit 4x AA NiMh Zellen • 2,4 GHz FHSS-System (Frequenz Hopping Spread Spectrum) • zwei stufenlos regelbare vollproportionale Kanäle • Servo-Reverse für beide Kanäle (Umkehrung der Laufrichtung) • Trimmfunktion für Gas und Lenkung • Dual Rate für beide Kanäle (Wegbegrenzung der Servos) • Stromversorgung des Empfängers (ohne BEC) ist bis 11,1V möglich • Integriertes Fail-Safe (programmierbar) • Uni-Steckersystem für Futaba und Graupner-J/R • Ladebuchse (Pluspol innen) • Batteriezustandsanzeige mittels LED.

Technical Data: Operating Voltage 4,8 bis 6 V • Operation with 4x AA NiMh batteries • 2,4 GHz FHSS-System (Frequenz Hopping Spread Spectrum) • two continuously controllable fully proportional channels • servo reverse for both channels (reversal of the running direction) • trimming function for accelerator and steering • Dual Rate for both channels (path limitation of the servos) • powering of receiver (without BEC) up to 11,1 V possible • Integrated Fail-Safe (programmable) • plug system for Futaba and Graupner-J/R • charging socket (plus terminal inside) • battery status indicator by LED.

N° 500500058

Reflex Wheel X1 2.4 GHz Blue



Lieferumfang: 2-Kanal, 2,4 GHz Sender, Mini-Empfänger, Mehrsprachiges Handbuch.

Scope of delivery: 2 Channel, 2,4 GHz transmitter, mini receiver, manual in several languages.



Technische Daten: Betriebsspannung Sender 4,8 bis 6V • Betrieb mit 4x AA NiMh Zellen • 2,4 GHz FHSS-System (Frequenz Hopping Spread Spectrum) • zwei stufenlos regelbare vollproportionale Kanäle • Servo-Reverse für beide Kanäle (Umkehrung der Laufrichtung) • Trimmfunktion für Gas und Lenkung • Dual Rate für beide Kanäle (Wegbegrenzung der Servos) • Stromversorgung des Empfängers (ohne BEC) ist bis 11,1V möglich • Integriertes Fail-Safe (programmierbar) • Uni-Steckersystem für Futaba und Graupner-J/R • Ladebuchse (Pluspol innen) • Batteriezustandsanzeige mittels LED.

Technical Data: Operating Voltage 4,8 bis 6 V • Operation with 4x AA NiMh batteries • 2,4 GHz FHSS-System (Frequenz Hopping Spread Spectrum) • two continuously controllable fully proportional channels • servo reverse for both channels (reversal of the running direction) • trimming function for accelerator and steering • Dual Rate for both channels (path limitation of the servos) • powering of receiver (without BEC) up to 11,1 V possible • Integrated Fail-Safe (programmable) • plug system for Futaba and Graupner-J/R • charging socket (plus terminal inside) • battery status indicator by LED.

N° 500500049
FS Reflex X2 2-Kanal 2.4 GHz



Lieferumfang: 2-Kanal, 2,4 GHz Sender, Mini-Empfänger, Mehrsprachiges Handbuch.
Scope of delivery: 2 Channel, 2,4 GHz transmitter, mini receiver, manual in several languages.



- 4 verschiedene Crawler Lenkeinstellungen / 4 various Crawler steering settings
- 15 Modellspeicher / 15 storage devices
- Akku-Tester für 2-3S LiPo-Akkus / Battery tester for 2-3S LiPo batteries
- Temperatur-Sensor / Temperature sensor
- Tempomat für Auto und Boot / Cruise control for car and boat
- Integrierte LED-Taschenlampe / Integrated LED torch



N° 500501016
FS Reflex Wheel LCD 2.4 GHz 7 Kanal

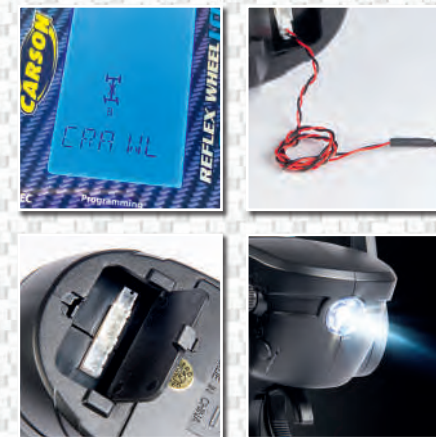

Lieferumfang: 2-Kanal, 2,4 GHz Sender, Mini-Empfänger, Mehrsprachiges Handbuch.
Scope of delivery: 2 Channel, 2,4 GHz transmitter, mini receiver, manual in several languages.



Hervorragend für den Einsatz von RC Autos! / Perfect for use in RC cars!

- 2 steuerbare Kanäle / 2 controllable channels
- Mini Empfänger/ Mini receiver
- Dual Rate für Lenkung / Dual Rate for steering

Technische Daten: Betriebsspannung Sender 4,8 bis 6V • Betrieb mit 4x AA NiMH Zellen • 2,4 GHz FHSS-System (Frequenz Hopping Spread Spectrum) • zwei stufenlos regelbare vollproportionale Kanäle • Servo-Reverse für beide Kanäle (Umkehrung der Laufrichtung) • Trimmfunktion für Gas und Lenkung • Dual Rate für Lenkung (Wegbegrenzung der Servos) • Stromversorgung des Empfängers (ohne BEC) ist bis 11,1V möglich • Integriertes Fail-Safe (programmierbar) • Uni-Steckersystem für Futaba und Graupner-J/R • Ladebuchse (Pluspol innen) • Batteriezustandsanzeige mittels LED.

Technical Data: Operating Voltage 4,8 bis 6 V • Operation with 4x AA NiMH batteries • 2,4 GHz FHSS-System (Frequenz Hopping Spread Spectrum) • two continuously controllable fully proportional channels • servo reverse for both channels (reversal of the running direction) • trimming function for accelerator and steering • Dual Rate for steering (path limitation of the servos) • powering of receiver (without BEC) up to 11,1 V possible • Integrated Fail-Safe (programmable) • plus system for Futaba and Graupner-J/R • charging socket (plus terminal inside) • battery status indicator by LED.



N° 500500084
FS Reflex Stick Pro 3.1 2.4 GHz 2 Kanal / Channel

Lieferumfang: 2-Kanal, 2,4 GHz Sender, 4-Kanal Empfänger, Anleitung.
 Scope of delivery: 2 Channel, 2,4 GHz transmitter, 4 channel receiver, manual.

Ersatz & Optionale Teile / Spare & Option Parts

500501533



Empfänger Reflex Wheel PRO3 2.4 GHz
 Receiver Reflex Wheel PRO3 2.4 GHz

500501534



Empfänger / Receiver Reflex Wheel PRO3 2.4 GHz
 waterresistant

500501535



Empfänger Reflex Wheel PRO3 2.4 GHz BEC
 Receiver Reflex Wheel PRO3 2.4 GHz BEC

500501536



Empfänger / Receiver Reflex Wheel PRO3 2.4 GHz
 BEC waterresistant

500609042



Mignon Set NiMH Akku 1,2V / 2100 mAh

500906128



Micro-Fail Safe wasserdicht
 Micro-Fail Safe waterproof

500608104



Akkupack Empfänger 6V/1600 mAh NiMH.
 Mit BEC-Steckersystem. / The pack consists of
 2/3AA cells. With BEC connector system.

500501538



Empfänger Reflex Wheel PRO3 Nano RX 2.4 GHz
 Receiver Reflex Wheel PRO3 Nano RX 2.4 GHz

500502042



Servo CS-9 waterproof 9kg/JR Stecker
 Servo CS-9 waterproof 9kg/JR Plug



Hervorragend für den Einsatz von RC Autos! / Perfect for use in RC cars!

Technische Daten: Betriebsspannung Sender 4,8 bis 6 V • Betrieb mit 4x AA NiMH Zellen möglich • 2.4G FHSS-System (Frequenz Hopping Spread Spectrum) • zwei stufenlos regelbare vollproportionale Kanäle • zwei zusätzliche Schaltkanäle für Sonderfunktionen • Servo-Reverse für alle Kanäle (Umkehrung der Laufrichtung) • Trimmfunktion für Gas und Lenkung • Dual Rate für Gas und Lenkung (Wegbegrenzung der Servos) • EPA (Servowegbegrenzung) für Gas und Lenkung • EXPO-Funktion für Gas und Lenkung (Exponential) • Stromversorgung des Empfängers (ohne BEC) ist bis 11,1V möglich • Integriertes Fail-Safe (programmierbar) • Uni-Steckersystem für Futaba und Graupner-J/R • Ladebuchse (Pluspol innen)

Technical Data: Operating Voltage 4,8 bis 6 V • Operation with 4x AA NiMH batteries • 2.4G FHSS-System (Frequency Hopping Spread Spectrum) • two continuously controllable fully proportional channels • two additional channels for special functions • servo reverse for both channels (reversal of the running direction) • trimming function for accelerator and steering • Dual Rate for both channels (path limitation of the servos) • EPA (path limitation of servos) for acceleration and steering • EXPO function for throttle and steering (exponential) • powering of receiver (without BEC) up to 11,1 V possible • Integrated Fail-Safe (programmable) • plug system for Futaba and Graupner-J/R • charging socket (plus terminal inside).



15 Modellspeicher



- 2 steuerbare Kanäle, 2 schaltbare Kanäle / two controllable channels, two additional channels
- 15 Modellspeicher / 15 model memory

N° 500500085
FS Reflex Stick Pro 3.1 2.4 GHz LCD 4 Kanal / Channel

Lieferumfang: 4-Kanal, 2.4 GHz Sender, 4-Kanal Empfänger, Anleitung.
 Scope of delivery: 4 Channel, 2.4 GHz transmitter, 4 channel receiver, manual.

Ersatz & Optionale Teile / Spare & Option Parts

| | | | | | |
|--|--|--|--|---|--|
| <p>500501533</p> <p>Empfänger Reflex Wheel PRO3 2.4 GHz Receiver Reflex Wheel PRO3 2.4 GHz</p> | <p>500501534</p> <p>Empfänger / Receiver Reflex Wheel PRO3 2.4 GHz water resistant</p> | <p>500501535</p> <p>Empfänger Reflex Wheel PRO3 2.4 GHz BEC Receiver Reflex Wheel PRO3 2.4 GHz BEC</p> | <p>500501536</p> <p>Empfänger / Receiver Reflex Wheel PRO3 2.4 GHz BEC water resistant</p> | <p>500609042</p> <p>Mignon Set NiMH Akku 1,2 V / 2100 mAh</p> | <p>500906128</p> <p>Micro-Fail Safe wasserdicht Micro-Fail Safe waterproof</p> |
| <p>500608104</p> <p>Akkupack Empfänger 6V/1600 mAh NiMH. Mit BEC-Steckersystem. / The pack consists of 2/3AA cells. With BEC connector system.</p> | <p>500501538</p> <p>Empfänger Reflex Wheel PRO3 Nano RX 2.4 GHz / Receiver Reflex Wheel PRO3 Nano RX 2.4 GHz</p> | <p>500502042</p> <p>Servo CS-9 waterproof 9kg/JR Stecker Servo CS-9 waterproof 9kg/JR Plug</p> | | | |

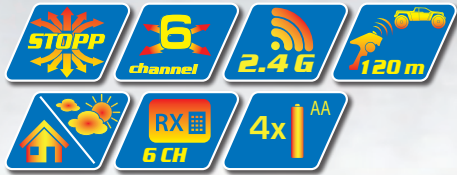

Technische Daten: Betriebsspannung Sender 4,8 - 6 V (4 AA Zellen) • 2,4 GHz FHSS-System (Frequenz Hopping Spread Spectrum) • 2,4 GHz - Servo-Reverse (Umkehrung der Laufrichtung) und Trimmfunktion für alle Kanäle • Stromversorgung für den Empfänger 4,8 - 6 V • Steckersystem Graupner-J/R.

Technical data: Operating voltage transmitter 4.8 - 6 V (4 AA batteries) • 2.4 GHz FHSS-System (Frequenz Hopping Spread Spectrum) • 2.4 GHz - servo reverse (reversal of running direction) and trimming function for all channels • power supply to the receiver 4.8 - 6 V • plug system Graupner-J/R.

- 4 steuerbare Kanäle, 2 schaltbare Kanäle / four controllable channels, two additional channels
- Kompatibel zu MFC, DMD von TAMIYA und LR-634 CU von CARSON / Compatible with MFC, DMD by TAMIYA and LR-634 CU by CARSON

N° 500501006

Reflex Stick 2 2.4 GHz 6 Kanal / Channel



Lieferumfang: 6-Kanal, 2,4 GHz Sender, 6-Kanal Empfänger, Mehrsprachiges Handbuch.

Scope of delivery: 6 Channel, 2.4 GHz transmitter, 6 channel receiver, manual in several languages.

Ersatz & Optionale Teile / Spare & Option Parts

500501533



Empfänger Reflex Wheel PRO3 2.4 GHz
Receiver Reflex Wheel PRO3 2.4 GHz

500501534



Empfänger / Receiver Reflex Wheel PRO3 2.4 GHz
waterresistant

500501535



Empfänger Reflex Wheel PRO3 2.4 GHz BEC
Receiver Reflex Wheel PRO3 2.4 GHz BEC

500501536



Empfänger / Receiver Reflex Wheel PRO3 2.4 GHz
BEC waterresistant

500501537



6-Kanal Empfänger Reflex Stick 2
6 Channel Receiver Reflex Stick 2

500906128



Micro-Fail Safe wasserdicht
Micro-Fail Safe waterproof

500609042



Mignon Set NIMH Akku 1,2 V / 2100 mAh

500503060



Reflex 6/14Ch Switch 2
Reflex 6/14Ch Switch 2

500503061



Reflex 6/14Ch Switch 4
Reflex 6/14Ch Switch 4

500503062



Reflex Switch 2/4 Stromverteiler
Reflex Switch 2/4 Stromverteiler

500502042



Servo CS-9 waterproof 9kg/JR Stecker
Servo CS-9 waterproof 9kg/JR Plug

Technische Daten: Betriebsspannung Sender 4,8 - 6 V (4 AA Zellen) • 2.4G FHSS-System (Frequenz Hopping Spread Spectrum) • 2.4G - Servo-Reverse (Umkehrung der Laufrichtung) und Trimmfunktion für alle Kanäle • Stromversorgung für den Empfänger 4,8 - 6 V • Steckersystem Graupner-J/R.

Technical data: Operating voltage transmitter 4.8 - 6 V (4 AA batteries) • 2.4G FHSS-System (Frequenz Hopping Spread Spectrum) • 2.4G - servo reverse (reversal of running direction) and trimming function for all channels • power supply to the receiver 4.8 - 6 V • plug system Graupner-J/R.



N° 500501015
Reflex Stick Truck-Set 2.4 GHz 6 Kanal / Channel

Lieferumfang: 6-Kanal, 2.4 GHz Sender, 1x Servo CS6, 1x Servo CS3, LED Truck Light, Truck Regler, Truck Motor, Expert Charger 1A, 7,2V Akku 2100 mAh, Anleitung.
Scope of delivery: 6 Channel, 2.4 GHz transmitter, 1x Servo CS6, 1x Servo CS3, LED Truck Light, Truck control unit, Truck Motor, Expert Charger 1A, 7,2V Akku 2100 mAh, manual.

Ersatz & Optionale Teile / Spare & Option Parts

| | | | | | |
|--|--|--|---|--|--|
| <p>500501533</p> <p>Empfänger Reflex Wheel PRO3 2.4 GHz Receiver Reflex Wheel PRO3 2.4 GHz</p> | <p>500501534</p> <p>Empfänger / Receiver Reflex Wheel PRO3 2.4 GHz water resistant</p> | <p>500501535</p> <p>Empfänger Reflex Wheel PRO3 2.4 GHz BEC Receiver Reflex Wheel PRO3 2.4 GHz BEC</p> | <p>500501536</p> <p>Empfänger / Receiver Reflex Wheel PRO3 2.4 GHz BEC water resistant</p> | <p>500501537</p> <p>6-Kanal Empfänger Reflex Stick 2 6 Channel Receiver Reflex Stick 2</p> | <p>500501540</p> <p>Empfänger Reflex Stick Multi Pro 14 Kanal Receiver Reflex Stick Multi Pro 14 channel</p> |
| <p>500609042</p> <p>Mignon Set NiMH Akku 1,2 V / 2100 mAh</p> | <p>500503060</p> <p>Reflex 6/14Ch Switch 2 Reflex 6/14Ch Switch 2</p> | <p>500503061</p> <p>Reflex 6/14Ch Switch 4 Reflex 6/14Ch Switch 4</p> | <p>500503062</p> <p>Reflex Switch 2/4 Stromverteiler Reflex Switch 2/4 Stromverteiler</p> | <p>500502042</p> <p>Servo CS-9 waterproof 9kg/JR Stecker Servo CS-9 waterproof 9kg/JR Plug</p> | |



Technische Daten: Betriebsspannung Sender 4,8 - 6 V (4 AA Zellen) • 2,4 GHz FHSS-System (Frequenz Hopping Spread Spectrum) • 2,4 GHz - Servo-Reverse für Kanal 1-4 (Umkehrung der Laufrichtung) und Trimmfunktion für Kanäle 1-4 • 4x Taster AN/AUS • 3x Schalter AN/AUS/AN • 3x Schalter AN/AUS • Stromversorgung für den Empfänger 4,8 - 6 V • Steckersystem Graupner-J/R • Ladebuchse (Pluspol innen) • Batteriezustandsanzeige mittels LED.

Technical data: Operating voltage transmitter 4.8 - 6 V (4 AA batteries) • 2.4 GHz FHSS-System (Frequenz Hopping Spread Spectrum) • 2.4 GHz - servo reverse for channels 1-4 (reversal of running direction) and trimming function for channels 1-4 • 4x button ON/OFF • 3x switch ON/OFF/ON • 3x switch ON/OFF • power supply to the receiver 4.8 - 6 V • plug system Graupner-J/R • charging socket (plus terminal inside) • battery status indicator by LED.



- 14 steuerbare Kanäle / 14 controllable channels
- Kompatibel zu MFC, DMD von TAMIYA / Compatible with MFC, DMD by TAMIYA

Lieferumfang: 14-Kanal, 2,4 GHz Sender, 14-Kanal Empfänger, Mehrsprachiges Handbuch.
 Scope of delivery: 14 Channel, 2,4 GHz transmitter, 14 channel receiver, manual in several languages.

N° 500501003
 Reflex Stick Multi Pro 2.4 GHz 14 Kanal / Channel

Ersatz & Optionale Teile / Spare & Option Parts

500501533



Empfänger Reflex Wheel PRO3 2.4 GHz
 Receiver Reflex Wheel PRO3 2.42.4 GHz

500501534



Empfänger / Receiver Reflex Wheel PRO3
 2.42.4 GHz water resistant

500501535



Empfänger Reflex Wheel PRO3 2,42.4 GHz
 BEC
 Receiver Reflex Wheel PRO3 2.42.4 GHz BEC

500501536



Empfänger / Receiver Reflex Wheel PRO3
 2.42.4 GHz BEC water resistant

500501537



6-Kanal Empfänger Reflex Stick 2
 6 Channel Receiver Reflex Stick 2

500501540



Empfänger Reflex Stick Multi Pro 14 Kanal
 Receiver Reflex Stick Multi Pro 14 channel

500906128



Micro-Fail Safe wasserdicht
 Micro-Fail Safe waterproof

500609042



Mignon Set NiMH Akku 1,2 V / 2100 mAh

500503060



Reflex 6/14Ch Switch 2
 Reflex 6/14Ch Switch 2

500503061



Reflex 6/14Ch Switch 4
 Reflex 6/14Ch Switch 4

500503062



Reflex Switch 2/4 Stromverteiler
 Reflex Switch 2/4 Stromverteiler

500502042



Servo CS-9 waterproof 9kg/JR Stecker
 Servo CS-9 waterproof 9kg/JR Plug



Technische Daten: Betriebsspannung Sender 4,8 - 6 V (4 AA Zellen) • 2,4 GHz FHSS-System (Frequenz Hopping Spread Spectrum) • 2,4 GHz Servo-Reverse (Umkehrung der Laufrichtung) und Trimmfunktion für Kanäle • 4x Taster AN/AUS/AN • 4x Schalter AN/AUS/AN • Stromversorgung für den Empfänger 4,8 - 6 V • Steckersystem Graupner-J/R • 2x Drehpotentiometer • Dual Rate Kanal 1-4 (Wegbegrenzung der Servos) • EPA Kanal 1-4 (Servowegbegrenzung) • ABS Funktion Kanal 1-4 (Stotterbremse) • EXP Funktion Kanal 1-4 (Exponential) • Failsafe Funktion.

Technical data: Operating voltage transmitter 4.8 - 6 V (4 AA batteries) • 2.4 GHz FHSS-System (Frequency Hopping Spread Spectrum) • 2.4 GHz servo reverse (reversal of running direction) and trimming function for channels • 4x button ON/OFF/ON • 4x switch ON/OFF/ON • power supply to the receiver 4.8 - 6 V • plug system Graupner-J/R • 2x Rotary potentiometer • Dual Rate for steering (path limitation of the servos) • EPA (servo travel limiting) • ABS function • EXP (exponential) • failsafe function.



15 Modellspeicher



- 14 steuerbare Kanäle / 14 controllable channels
- LCD Display / LCD display
- 15 Modellspeicher / 15 model memory

N° 500501004

FS Reflex Stick Multi Pro LCD 2.4 GHz 14 Kanal / Channel

Lieferumfang: 14-Kanal, 2,4 GHz Sender, 14-Kanal Empfänger, Mehrsprachiges Handbuch.
Scope of delivery: 14 Channel, 2.4 GHz transmitter, 14 channel receiver, manual in several languages.

Ersatz & Optionale Teile / Spare & Option Parts

500609042

Mignon Set NiMH Akku 1,2 V / 2100 mAh

500503032

Schalterkabel BEC Ein-Aus-Schalter mit BEC-Anschluß / Switch cable BEC On-off switch with BEC connector

500501544

Empfänger Reflex Stick Multi Pro LCD 14 Kanal Receiver Reflex Stick Multi Pro LCD 14 channel

500906239

LED Lichterset 2 rot + 2 weiß über Fernsteuerung schaltbar, 4,4 - 6V / LED Light set 2 red + 2 white switchable by transmitter, 4,4 - 6V

500906240

LED Lichterset 4 rot + 4 weiß über Fernsteuerung schaltbar, 4,4 - 6V / LED Light set 4 red + 4 white switchable by transmitter, 4,4 - 6V

500503060

Reflex 6/14Ch Switch 2 Reflex 6/14Ch Switch 2

500503061

Reflex 6/14Ch Switch 4 Reflex 6/14Ch Switch 4

500503062

Reflex Switch 2/4 Stromverteiler Reflex Switch 2/4 Stromverteiler

500502041

Servo CS-6 waterproof 6kg/JR Stecker Servo CS-6 waterproof 6kg/JR Plug

500502042

Servo CS-9 waterproof 9kg/JR Stecker Servo CS-9 waterproof 9kg/JR Plug

500502047

Servo CS-6 lowprofile waterproof 6kg/JR Stecker (Servo CS-6 lowprofile waterproof 6kg/JR Plug



Technische Daten: Betriebsspannung Sender 4,8 - 6 V (4 AA Zellen) • 2,4 GHz FHSS-System (Frequenz Hopping Spread Spectrum) • 2,4 GHz - Servo-Reverse (Umkehrung der Laufrichtung) und Trimmfunktion für alle Kanäle • Stromversorgung für den Empfänger 4,8 - 6 V • Steckersystem Graupner-J/R.

Technical data: Operating voltage transmitter 4.8 - 6 V (4 AA batteries) • 2.4 GHz FHSS-System (Frequenz Hopping Spread Spectrum) • 2.4 GHz - servo reverse (reversal of running direction) and trimming function for all channels • power supply to the receiver 4.8 - 6 V • plug system Graupner-J/R.

- 4 steuerbare Kanäle, 2 schaltbare Kanäle / four controllable channels, two additional channels
- Kompatibel zu MFC, DMD von TAMIYA und LR-634 CU von CARSON / Compatible with MFC, DMD by TAMIYA and LR-634 CU by CARSON

N° 500501007

Reflex Stick II Extreme Carbon 2.4 GHz 6 Kanal / Channel



Lieferumfang: 6-Kanal, 2,4 GHz Sender, 6-Kanal Empfänger, Mehrsprachiges Handbuch.

Scope of delivery: 6 Channel, 2.4 GHz transmitter, 6 channel receiver, manual in several languages.



Technische Daten: Betriebsspannung Sender 4,8 - 6 V (4 AA Zellen) • 2,4 GHz FHSS-System (Frequenz Hopping Spread Spectrum) • 2,4 GHz - Servo-Reverse (Umkehrung der Laufrichtung) und Trimmfunktion für alle Kanäle • Stromversorgung für den Empfänger 4,8 - 6 V • Steckersystem Graupner-J/R.

Technical data: Operating voltage transmitter 4.8 - 6 V (4 AA batteries) • 2.4 GHz FHSS-System (Frequenz Hopping Spread Spectrum) • 2.4 GHz - servo reverse (reversal of running direction) and trimming function for all channels • power supply to the receiver 4.8 - 6 V • plug system Graupner-J/R.

- 4 steuerbare Kanäle, 2 schaltbare Kanäle / four controllable channels, two additional channels
- Kompatibel zu MFC, DMD von TAMIYA und LR-634 CU von CARSON / Compatible with MFC, DMD by TAMIYA and LR-634 CU by CARSON

N° 500501008

Reflex Stick II Camouflage 2.4 GHz 6 Kanal / Channel



Lieferumfang: 6-Kanal, 2,4 GHz Sender, 6-Kanal Empfänger, Mehrsprachiges Handbuch.

Scope of delivery: 6 Channel, 2.4 GHz transmitter, 6 channel receiver, manual in several languages.



Servos / Servos

500502034



Servo CS-20 20kg/JR Stecker
Servo CS-20 20kg/JR Plug

500502015



Servo CS-3 3kg/JR Stecker
Servo CS-3 3kg/JR Plug

500502016



Servo CS-5 5kg/JR Stecker
Servo CS-5 5kg/JR Plug

500502036



Servo CS-6 6kg/JR Stecker
Servo CS-6 6kg/JR Plug

500502024



Servo CS-9 9kg/JR Stecker
Servo CS-9 9kg/JR Plug

500502035



Servo CS-3 lowprofile waterproof 3kg/JR Stecker
Servo CS-3 lowprofile waterproof 3kg/JR Plug

500502041



Servo CS-6 waterproof 6kg/JR Stecker
Servo CS-6 waterproof 6kg/JR Plug

500502042



Servo CS-9 waterproof 9kg/JR Stecker
Servo CS-9 waterproof 9kg/JR Plug

500502025



Servo CS-13 waterproof 13kg/JR Stecker
Servo CS-13 waterproof 13kg/JR Plug

| Art.-Nr. / N° | Bezeichnung / Description | Kraftmoment Set 6V | Geschwindigkeit time/sec | Gewicht/g weight/g | L/B/H mm l/w/h mm | Getriebe Gear | Wasserfest water resistant |
|---------------|--------------------------------------|--------------------|--------------------------|--------------------|-------------------|-----------------------------|----------------------------|
| 500502015 | CS-3 | 30 | 0,16 | 39 | 38,5 x 19 x 32 | Kunststoff / Plastic | - |
| 500502016 | CS-5 | 50 | 0,17 | 39 | 38,5 x 19 x 32 | Kunststoff / Plastic | - |
| 500502036 | CS-6 | 60 | 0,2 | 50 | 38,5 x 19 x 32 | Metallgetriebe / metal gear | - |
| 500502024 | CS-9 MG | 98 | 0,1 | 50 | 40 x 20 x 38 | Metallgetriebe / metal gear | - |
| 500502025 | CS-13 MG | 135 | 0,12 | 49 | 41 x 20 x 38 | | X |
| 500502034 | CS-20 MG | 225 | 0,2 | 145 | 75,8 x 53,9 x 32 | | X |
| 500502041 | CS-6 water resistant / JR | 60 | 0,2 | 50 | 38,5 x 19 x 32 | Metallgetriebe / metal gear | X |
| 500502042 | CS-9 water resistant / JR | 98 | 0,1 | 50 | 40 x 20 x 38 | Metallgetriebe / metal gear | X |
| 500502035 | CS-3 LowProfile water resistant / JR | 30 | 0,16 | 35 | 38,5 x 19 x 25 | Metallgetriebe / metal gear | X |
| 500502047 | CS-6 LowProfile water resistant / JR | 60 | 0,16 | 35 | 38,5 x 19 x 25 | Metallgetriebe / metal gear | X |

500502047



Servo CS-6 lowprofile waterproof 6kg/JR Stecker
Servo CS-6 lowprofile waterproof 6kg/JR Plug

WASSERFEST
WATER RESISTANT

Diese Servos sind entwickelt worden, um auch bei nassen, feuchten Bedingungen eingesetzt zu werden (Pfützen und Regen). Der Servo darf jedoch nicht unter Wasser getaucht werden.

This servos are designed, to it can be use in wet conditions (puddles and rain). Servo shall not be submerged under water.

500503051
500503054



| Art.-Nr. / N° | Artikel / Item |
|---------------|------------------------------------|
| 500503051 | Alu Servo Horn 27mm Carson/FUT 25Z |
| 500503054 | Alu Servo Horn 33mm Carson/FUT 25Z |

LED's & Beleuchtung / LEDs and lighting units

500906153



LED-Lichteinheit Drift /
LED-Light set Drift

500906154



LED-Lichteinheit Race /
LED-Light set Race

500906166



LED-Lichteinheit TRUCK /
LED-Light set TRUCK

500906232



LED Lichtersetblau, 4,4 - 6V, Länge 9 cm
LED Light set blue, 4,4 - 6V, Length 9 cm

500906235

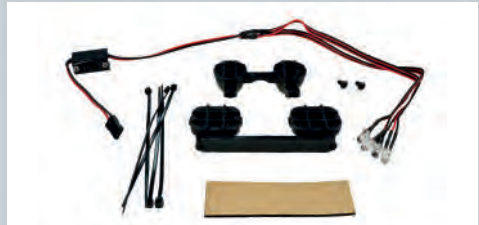

LED Lichterset TAMIYA, 4,4 - 6V
LED Light set TAMIYA, 4,4 - 6V

500906239



LED Lichterset 2 rot + 2 weiß über Fernsteuerung schaltbar, 4,4 - 6V
LED Light set 2 red + 2 white switchable by transmitter, 4,4 - 6V

500906240



LED Lichterset 4 rot + 4 weiß über Fernsteuerung schaltbar, 4,4 - 6V
LED Light set 4 red + 4 white switchable by transmitter, 4,4 - 6V

500405692



LED Lichterset universal, 4,4 - 6V
LED Light set universal, 4,4 - 6V

Motorsound / Engine sound



Der Motorsound für heiße Rennmaschinen!

Das Soundmodul ist superklein, leicht zu bedienen und einfach einzubauen. Ein Mikroprozessor gibt den Motorsound, der an den echten Vorbildern aufgenommen wurde, über einen Minilautsprecher wieder. Sound-Tuning für coole Elektromodelle!

Technische Daten: Für brushed und brushless Modelle • Eingangsspannung 6-12 V • Lautstärke stufenlos einstellbar • mit TAMIYA Stecker • Abmessungen Soundmodul: 90x40x28 mm • Gewicht ca. 83 g

The engine sound for hot racing machines!

The sound module is super small, easy to operate and easy to install. A microprocessor relays an engine sound recorded from a genuine vehicle through a mini loudspeaker. Sound tuning for cool electric models!

Technical data: for brushed and brushless models • input voltage 6-12 V • smoothly adjustable volume • with TAMIYA plug • sound module dimensions: 90x40x28 mm • weight approx. 83 g

| Art.-Nr. / N° | Artikel / Item |
|---------------|---------------------------|
| 500906265 | Motor-Sound unit On-Road |
| 500906266 | Motor-Sound unit Off-Road |
| 500906267 | Motor-Sound unit Truck |



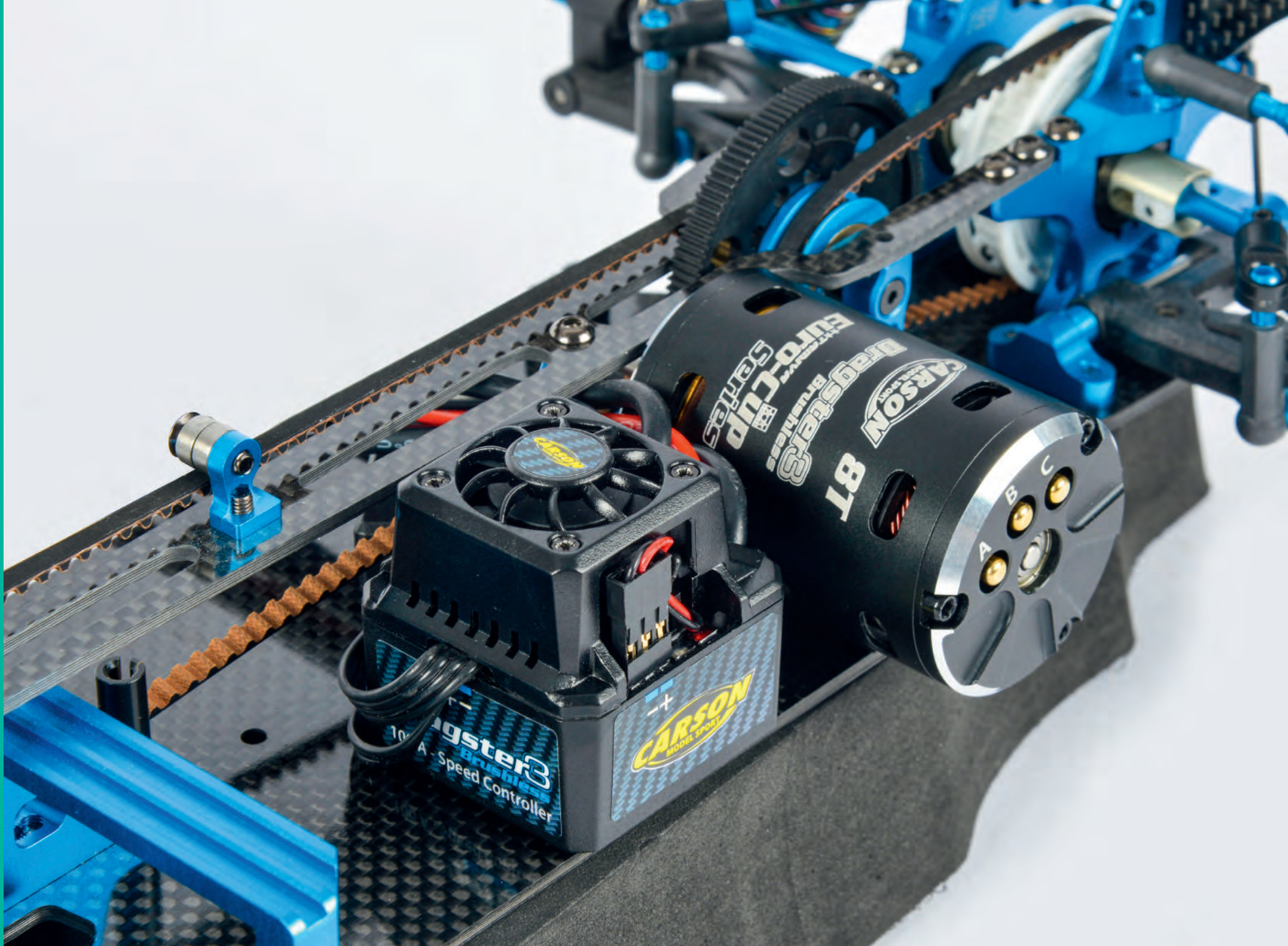



| Art.-Nr./N° | Type | Turns | Maße LxBxH / Size LxHxW | U/Min. / RPM | Gewicht / Weight | Leistung / Power |
|-------------|------------------------------------|-------|-------------------------|--------------|------------------|------------------|
| 500906280 | Race | 12Tx2 | 70x35x35 | 32.500 | 164 g | 160 W |
| 500906281 | Race | 17Tx2 | 70x35x35 | 27.500 | 164 g | 150 W |
| 500906282 | Race | 19Tx2 | 70x35x35 | 23.500 | 164 g | 140 W |
| 500906283 | Drift | 21Tx2 | 70x35x35 | 20.000 | 164 g | 130 W |
| 500906284 | Crawler | 55Tx2 | 70x35x35 | 8.000 | 164 g | 80 W |
| 500906285 | Truck | 80Tx2 | 70x35x35 | 5.300 | 164 g | 75 W |
| 500906286 | Motorkohlen Launcher (2 St./pcs.) | | | | | |
| 500906288 | 1:10 Motorkühlkörper mit Toplüfter | | | | | |
| 500906289 | 1:8 Motorkühlkörper mit Toplüfter | | | | | |



500906197
Elektromotor 540 Black Race Machine /
Electric engine 540 Black Race Machine

Nennspannung 6 V • Spannungsbereich 4,8–8,4 V •
 Drehzahl 28.000 UpM • Stromaufnahme 2,2 A •
 Drehmoment 1,8 Ncm • Stromaufnahme 10 A •
 Abgabe 120 W

Nominal voltage 6 V • voltage range 4.8–8.4 V • rotational speed 28,000 rpm • rotational speed 16.400 rpm • torque 1.8 Ncm • current consumption 10 A.

500906052
Elektromotor Cup
Machine 23T /
Electric engine Cup Machine 23T

Nennspannung 6 V • Spannungsbereich 4,8–8,4 V •
 Drehzahl 23.000 UpM • Stromaufnahme 1,95 A •
 Drehmoment 1,69 Ncm • Stromaufnahme 8,7 A •
 Abgabe 100 W

Nominal voltage 6 V • voltage range 4.8–8.4 V • rotational speed 23,000 rpm • rotational speed 16.400 rpm • torque 1.69 Ncm • current consumption 8.7 A.



500906264
Fahrregler Dragster Brushed 70A
Speed Controller Dragster Brushed 70A

| Funktion / function | Zellen NiMH cells NiMH | Zellen LiPo cells LiPo | Stromabgabe kurz peak current |
|---|--------------------------|------------------------|-------------------------------|
| Vorwärts / Bremse / Rückwärts forward / stop / backward | 6-8 | 2-3 | 360 A |
| Stromabgabe lang continuous current | Taktfrequenz Clock speed | Gewicht weight | Stecksystem plug system |
| 70 A | 16 kHz | 39 g | Tamiya / T-Plug |



Brushless-Set Fahrregler & Motoren Combo / Brushless-Set ESC & Motors *

| Art.-Nr. / N° | Bezeichnung/Description | Turns | Maße / Size (ØxL) | kV | U/Min./ RPM (7,2V) | Leistung / Power | Dauerstrom Continuous current |
|---------------|----------------------------|-------|-------------------|---------|--------------------|------------------|-------------------------------|
| 500906273 | Brushless Set DRAGSTER 8T | 8 | 36 x 55 mm | 4500 kV | 33.000 | 450 W | 63 A |
| 500906274 | Brushless Set DRAGSTER 12T | 12 | 36 x 55 mm | 3500 kV | 25.000 | 350 W | 50 A |
| 500906275 | Brushless Set DRAGSTER 14T | 14 | 36 x 55 mm | 3000 kV | 21.000 | 300 W | 45 A |



On-Road Version
für TAMIYA Regler TBLE-02S und TBLE-03S

500906258

BL Motor 11,5T sens. Dragster-Pro OR inkl. Sensorkabel / BL Motor 11,5T sens. Dragster-Pro OR incl. sensor cable



Off-Road Version
für TAMIYA Regler TBLE-02S und TBLE-03S

500906260

BL Motor 10,5T sens. Dragster-Pro OF inkl. Sensorkabel / BL Motor 10,5T sens. Dragster-Pro OF incl. sensor cable



Modul 0,6 für TAMIYA-Standard Modelle / Modul 0,6 for TAMIYA-Standard Models

| N° | Zähne / Teeth |
|-----------|---------------|
| 500013420 | 12 |
| 500013421 | 13 |
| 500013422 | 14 |
| 500013423 | 15 |
| 500013424 | 16 |
| 500013425 | 17 |
| 500013426 | 18 |
| 500013427 | 19 |
| 500013428 | 20 |
| 500013429 | 21 |
| 500013430 | 22 |
| 500013431 | 23 |
| 500013432 | 24 |
| 500013433 | 25 |
| 500011106 | 26 |
| 500011107 | 27 |
| 500011108 | 28 |
| 500011109 | 29 |

Modul 0,8 für TAMIYA-Off-Road Modelle / Modul 0,8 for TAMIYA-Off-Road Models

| N° | Zähne / Teeth |
|-----------|---------------|
| 500013400 | 10 |
| 500013401 | 11 |
| 500013437 | 12 |
| 500013403 | 13 |
| 500013439 | 14 |
| 500013405 | 15 |
| 500013406 | 16 |
| 500013407 | 17 |
| 500013408 | 18 |
| 500013409 | 19 |

Gehärtete Stahl-Motorritzel Modul 1 für 1:8 Brushlessmodelle / Cured steel pinions modul 1 for 1:8 brushless cars

| N° | Zähne / Teeth |
|-----------|---------------|
| 500906202 | 13 |
| 500906203 | 14 |
| 500906205 | 16 |
| 500906207 | 18 |
| 500906208 | 19 |

Fahrregler / Speed Controller

500906130

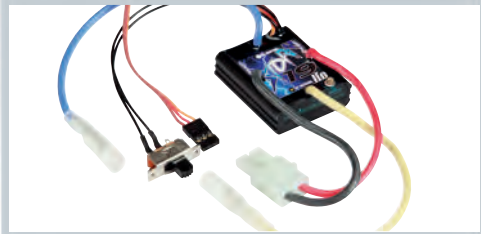

tio Storm 19

500906131

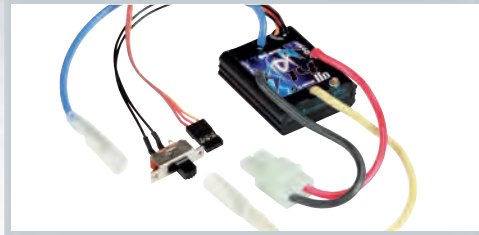

tio Storm 14

500906132

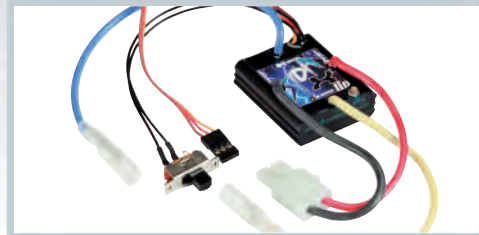

tio Storm X

500906133

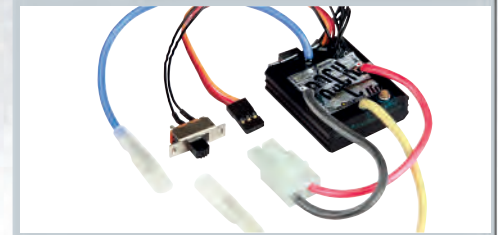

tio Storm RockC

500906134



Viper tuned 20

500906135

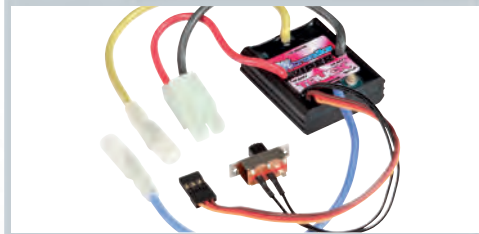

Viper Truck

500906136

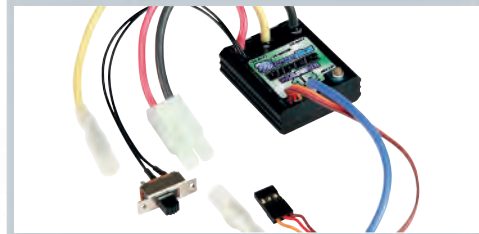

Viper marine 15

500906137



Viper Marine Micro

| | tio Storm 19 | tio Storm 14 | tio Storm X | tio Storm RockC | Viper tuned 20 | Viper Truck | Viper Marine Micro | Viper marine 15 | Viper Marine 25 | Viper Marine 40 | Viper Marine HV 20 |
|---|---|---|---|----------------------|-----------------|---|--------------------|-----------------|---|---|---|
| Technische Daten / technical datas | 500906130 | 500906131 | 500906132 | 500906133 | 500906134 | 500906135 | 500906137 | 500906136 | 500906261 | 500906262 | 500906263 |
| NiMH / LiPo | NiMH/ LiPo | NiMH/ LiPo | NiMH/ LiPo | NiMH/ LiPo | NiMH | NiMH | NiMH | NiMH | NiMH/PB | NiMH/PB | NiMH/PB/ LiPo |
| Motorlimit / motor limit | 19 T | 14 T | No | 35 T Crawler | 20 T | 15 T | 10 T | 15 T | 25 A | 40 A | 20 A |
| Zellenzahl / number of cells | 4 - 8 | 4 - 8 | 4 - 8 | 4 - 8 | 4 - 8 | 5 - 10 | 5 - 10 | 5 - 10 | 5 - 10 | 5 - 10 | 10-18/12-24V/3S-6S |
| Volt / volt | 4.8 - 9.6 V | 4.8 - 9.6 V | 4.8 - 9.6 V | 4.8 - 9.6 V | 4.8 - 9.6 V | 6 - 12 V | 6 - 12 V | 6 - 12 V | 6 - 12 V | 6 - 12 V | 12 - 24 V |
| Vorwärts / forward | ja / yes | ja / yes | ja / yes | ja / yes | ja / yes | ja / yes | ja / yes | ja / yes | ja / yes | ja / yes | ja / yes |
| Rückwärts / backward | ja (abschaltbar) / yes, can be switched off | ja (abschaltbar) / yes, can be switched off | ja (abschaltbar) / yes, can be switched off | ja / yes | ja / yes | ja / yes | ja / yes | ja / yes | ja (abschaltbar) / yes, can be switched off | ja (abschaltbar) / yes, can be switched off | ja (abschaltbar) / yes, can be switched off |
| Bremse / brake | ja / yes | ja / yes | ja / yes | ja / yes | ja / yes | ja / yes | nein / no | nein / no | nein / no | nein / no | nein / no |
| Bremspunkt einstellbar / adjustable braking point | nein / no | nein / no | nein / no | ja / yes (deadstick) | nein / no | nein / no Handbremsfunktion / Hand break function | nein / no | nein / no | nein / no | nein / no | nein / no |
| Frequenz / frequency | 3.3 KHz | 3.3 KHz | 3.3 KHz | 3.3 KHz | 3.3 KHz | 3.3 KHz | 1 KHz | 1 KHz | 1 KHz | 1 KHz | 1 KHz |
| BEC/A | 1.5 A | 1.5 A | 1.5 A | 5 A | 1.5 A | 3.0 A | 1.5 A | 1.5 A | 1.5 A | 1.5 A | 2.0 A |
| Gewicht mit Kabel / weight with cable | 55 g | 55 g | 55 g | 57 g | 54 g | 53 g | 23 g | 55 g | 55 g | 55 g | 75 g |
| Abmessung / dimensions | 40 x 35 x 12 mm | 40 x 35 x 12 mm | 40 x 35 x 12 mm | 40 x 35 x 12 mm | 40 x 35 x 12 mm | 40 x 35 x 12 mm | 26 x 25 x 9 mm | 39 x 34 x 13 mm | 39 x 34 x 13 mm | 39 x 34 x 13 mm | 60 x 37 x 13 mm |

500906261



Viper Marine 25

500906262



Viper Marine 40

500906263



Viper Marine HV 20

Die aktuelle Regler-Generation – gut und zuverlässig!
/ **The latest controller generation – good and authentic!**

Besonderheiten / Special features:

- 100 % wasserdicht / 100% waterproof
- Alle Einstellungen über einen Set Up Knopf / All adjustments via one set up button
- Integriertes Fail Safe / Integrated fail safe
- Schutz gegen Kurzschluss / Short-circuit protected
- Schutz vor Überlast / Overload protection
- Anschlussfertig mit Kabel / Complete with wires
- Ein-Aus Schalter / On-off switch

Brushless Sets 1:10 / Brushless Sets 1/10



Dragster³ Brushless



WASSERFEST
WATER RESISTANT

Diese Brushless Sets sind entwickelt worden, um auch bei nassen, feuchten Bedingungen fahren zu können (Pfützen und Regen). Fahrzeug und Komponenten dürfen jedoch nicht unter Wasser getaucht werden. Bitte unbedingt Hinweise in der Bedienungsanleitung beachten!

This brushless kits are designed, to it can be driven in wet conditions (puddles and rain). Vehicle and components shall not be submerged under water. Please pay attention to the notes contained in manual.

| Brushless Combo DRAGSTER 3 water resistant inkl./incl. Set-Up Box | | |
|---|----------------------|----------------------|
| Art.-Nr./N° | 500906246 | 500906247 |
| DRAGSTER 3 Motor sensorlos / sensorless | | |
| Windungen / Turns | 16T OnRoad/OffRoad | 18T OnRoad/OffRoad |
| kV | 2500 kV | 2000 kV |
| Eingang / Input | 6-8 NiMH / 2-3S LiPo | 6-8 NiMH / 2-3S LiPo |
| U/min bei 7,4 V / RPM at 7.4V | 18.500 | 14.800 |
| Geschwindigkeit OnRoad Chassis 1/10 / Speed | < 45 km/h | < 35 km/h |
| Dauerstrom / Continuous current | 38 A | 31 A |
| Abgabeleistung / Output | 280 W | 230 W |
| Maße / Size (D x L) | 36 x 53 mm | 36 x 53 mm |
| Shaft length | 13 mm | 13 mm |
| Shaft diameter | 3,175 mm | 3,175 mm |
| Gewicht / Weight | 175 g | 175 g |
| DRAGSTER 3 Brushlessregler / Brushless Controller | | |
| Eingang / Input | 6-8 NiMH / 2-3S LiPo | 6-8 NiMH / 2-3S LiPo |
| Dauerstrom / Continuous current | 100 A | 100 A |
| kurzzeitig / Peak current | 180 A | 180 A |
| Taktung / Clock speed | 16 kHz | 16 kHz |
| Gewicht m. Kabel / Weight | 90 g | 90 g |

500906246



Brushless-Set Dragster 3 - 16T

500906247



Brushless-Set Dragster 3 - 18T



Turnsgravur am Gehäuse /
Turns engraving on housing



Turnsgravur an Welle /
Turns engraving on shaft



Motor-Steckersystem /
Turns engraving on shaft



LCD Programmierbox enthalten /
LCD programm box included



OneTouch ein- und Ausschalter /
One touch on/off switch



Neueste Technik mit sehr feinem Reglerverhalten /
New technologie with finest performance

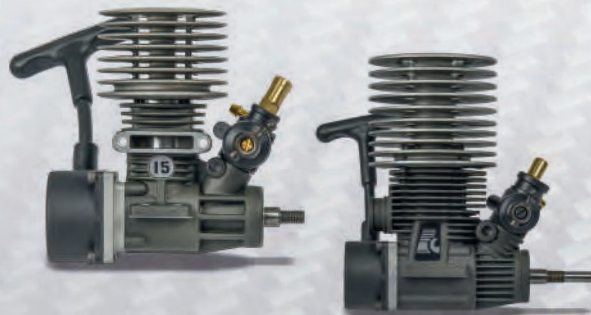
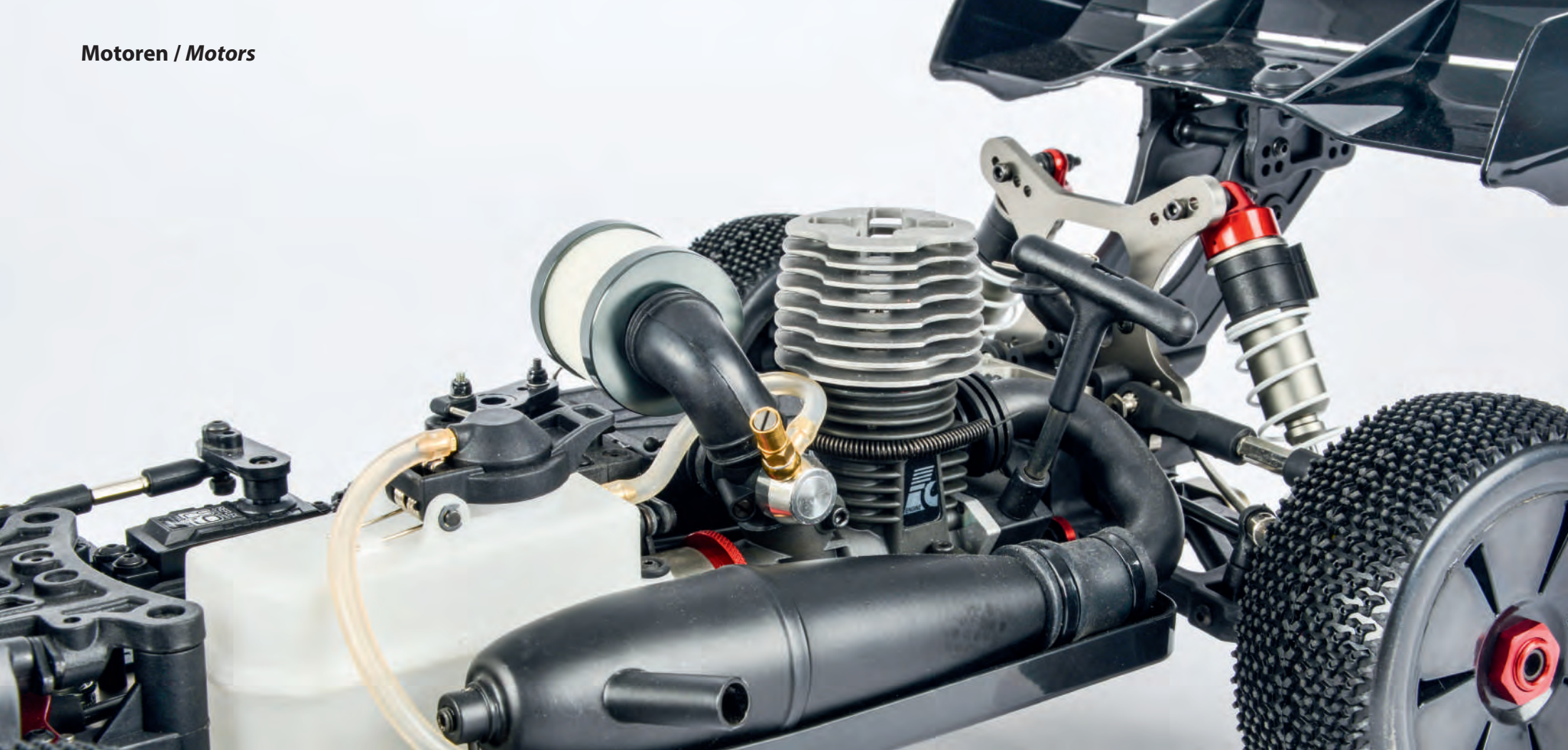

500901008
Force Motor 155/2,5ccm, O.S.-Welle

500901013
Force Motor 36R / 5.89 ccm SG / Seilzug / Bowden cable

Technische Daten Verbrennungsmotoren / technical data gas engines

| Art.-Nr. / N° | Typ / Type | Hubraum / Piston displacement | Leistung / Power | Drehzahl UpM / RPM | Gewicht / Weight |
|---------------|-------------|-------------------------------|------------------|--------------------|------------------|
| 500901008 | 155/OS | 2.5 ccm | 0.9 kW (1.2 PS) | 29.000 | 262 g |
| 500901013 | 0.36cu.i/SG | 5.9 ccm | 2.77kW (3.76PS) | 35.000 | 457 g |

Egal ob im Hochleistungs- oder Hobbyeinsatz – mit diesen Motoren liegen Sie immer richtig! Seit vielen Jahren produziert Force extrem zuverlässige, robuste und vor allem leistungsstarke Verbrennungsmotoren. Die sehr hohen Drehzahlen sprechen für diese Triebwerke. Die Vergaser sind werkseitig voreingestellt. Das leichte Starten mittels Seilzug- oder Elektrostarter, sowie das Einstellverhalten gestalten die Handhabung und den Einsatz dieser Motoren sehr einfach.

Whether it's for high-performance or hobby runs, this engine is right for you! For many years, Force has produced extremely reliable, robust and above all high-performance internal combustion engines. Very high RPM says it all. The carburetors are pretuned at the factory. Easy rope or electric starting, and adjustment behaviour, make handling this engine very simple.



**500905231
Bio Nitro-Fire 16%/1L Treibstoff /
Bio Fuel Nitro-Fire 16%/1l**

Geeignet für alle RC-Car Motoren im Spitzenbereich. Zuverlässiges Start- und Leerlaufverhalten. Maximale Spitzenleistung, sehr gute Notlaufeigenschaften.

Suitable for all top range RC car engines. Reliable start and Idling behavior. Maximum peak performance, very good emergency running properties.



Kraftstoff / Fire Fuel

| | Artikel / Article | Gebindegröße | Verwendungszweck | Öl-Anteil % | Methanol-Anteil % | Nitromethan-Anteil % |
|-----------|--|--------------|--|-----------------------------------|-------------------|----------------------|
| 500905214 | Powerglow RUN-IN, 1L, Einlaufreibst.8%NM | 1,0 Liter | Einlaufreibstoff für alle Anwendungen | 12% Synthetisch/Racing Rizinus | 77% | 8% |
| 500905208 | Powerglow J-L Classic JR, 1L, 15% NM | 1,0 Liter | Geeignet für alle RC-Car Motoren. Zuverlässiges Start- und Leerlaufverhalten. Gute Spitzenleistung, Gutes Notlaufverhalten | 12% Synthetisch/Racing Rizinus | 73% | 15% |
| 500905209 | Powerglow J-L Classic JR, 2,5L, 15% NM | 2,5 Liter | | | | |
| 500905210 | Powerglow J-L Classic JR, 5L, 15% NM | 5,0 Liter | | | | |
| 500905218 | Powerglow J-L Expert P, 1L, 16% NM | 1,0 Liter | Geeignet für alle RC-Car Motoren im Spitzenbereich. Zuverlässiges Start- und Leerlaufverhalten. Maximale Spitzenleistung, Sehr gute Notlaufeigenschaften | 12% Synthetisch/Racing Rizinus | 72% | 16% |
| 500905219 | Powerglow J-L Expert P, 2,5L, 16% NM | 2,5 Liter | | | | |
| 500905220 | Powerglow J-L Expert P, 5L, 16% NM | 5,0 Liter | | | | |
| 500905191 | Kraftstoff Nitro-Fire 16% Nitro/2L | 2,0 Liter | Geeignet für alle RC-Car Motoren im Spitzenbereich. Zuverlässiges Start- und Leerlaufverhalten. Maximale Spitzenleistung, Sehr gute Notlaufeigenschaften | 12% Synthetisch/Racing Rizinus | 72% | 16% |

**500905081
EMS-PRO Motor Start System**

Easy Motor Start-System zum einfachen Starten von Verbrennungsmotoren in Modellfahrzeugen (Maßstab 1:8/1:10). Der Starterflansch am Motorgehäuse ersetzt den Seilzugstarter. Der EMS-PRO (Easy Motor Starter) startet den Motor über eine Sechskantwelle. Als Stromversorgung des Starters benötigt man einen 7,2V Akkupack mit Tamiya-Stecker. Das Carson EMS Two Startsystem ist mit allen Force-Motoren kompatibel.

The perfect starter kit for drivers of combustion cars. The starter flange on the motor housing replaces the pull starter. The EMS-PRO (Easy Motor Starter) starts the motor via a hexagonal shaft. A 7.2V battery pack with a Tamiya plug is required to power the starter. The Carson EMS Two starting system is compatible with all Force engines.



**500905100
Startbox 1:8 / 1:10**

- für LiPo 7,4 V / NiMH 7,2 V Akkus ausgelegt / *Designed for LiPo 7.4 V / NiMH 7.2 V rechargeable batteries*
- Leistungsstarker Brushed-Motor / *Powerful brushed motor*
- Für 1/10 und 1/8 On-Road / Off-Road / *For 1/10 and 1/8 on-road/off-road*
- Einfache Anpassung an alle Chassis-Typen / *Easily adjusts to all chassis types*
- Massives Metallgehäuse / *Solid metal housing*
- T-Plug-Stecker für Akkus / *T-plug connector for batteries*



Rossi Profi Glühkerzen / Rossi Pro glow plugs

| | Artikel Article | Motorart Type of engine | Kraftstoffart Type of fuel | Temperatur Temperature |
|-----------|----------------------------|----------------------------|-------------------------------|---------------------------|
| 500905006 | Rossi R2 heiß | 2 – 3,5 ccm | ohne / without Nitro | +0° – +15°C |
| 500905007 | Rossi R3 med. | 3,5 – 6 ccm | ohne / without Nitro | -2° – +18°C |
| 500905008 | Rossi R4 kalt | 6 – 10 ccm | ohne / without Nitro | -5° – +20°C |
| 500905009 | Rossi R5 extra | 3,5 – 10 ccm | 10% Nitro | -7° – +22°C |
| 500905010 | Rossi R6 kalt | universal | 10 – 13% Nitro | +10° – +25°C |
| 500905011 | Rossi R7 kalt | universal | 13 – 15% Nitro | +15° – +30°C |
| 500905012 | R8 extra sehr kalt | 3,5 - 10 ccm | 15 – 30% Nitro | +20° – +40° |
| 500905017 | Rossi RFS 4-Takt | alle 4T Motoren | - | - |
| 500905020 | Rossi R1 extra heiß (kurz) | 0,8 - 2 ccm | 0 - 10% Nitro | +5° – +15°C |

Glühkerzen Jets / Glow plugs Jets

Premium Glühkerzen für den Universellen Einsatz für Glühzündermotoren.



| | Artikel Article | Motorart Type of engine | Kraftstoffart Type of fuel |
|-----------|--------------------------------|--|-------------------------------|
| 500905102 | Glühkerze Jets No.2 Extra Heiß | Car 1,80 - 3,50ccm / (0.11 - 0.21cu.i) Flug 3,50 - 9,95 ccm / (0.21 - 0.60cu.i) | 0 - 10% Nitro |
| 500905103 | Glühkerze Jets No.3 Sehr Heiß | Car 1,80 - 3,50ccm / (0.11 - 0.21cu.i) Flug 3,50 - 9,95 ccm / (0.21 - 0.60cu.i) | 0 - 10% Nitro |
| 500905104 | Glühkerze Jets No.4 Heiß | Car 1,80 - 3,50ccm / (0.11 - 0.21cu.i) Flug 3,50 - 9,95 ccm / (0.21 - 0.60cu.i) | 0 - 10% Nitro |
| 500905105 | Glühkerze Jets No.5 Standard | Universal Car 2,50 - 9,00ccm / (0.15 - 0.55cu.i) Flug 3,50 - 9,95 ccm / (0.21 - 0.61cu.i) Heli 4,90 - 9,95ccm / (0.30 - 0.60cu.i) | 10 - 16% Nitro |
| 500905106 | Glühkerze Jets No.6 Standard | Universal Car 2,50 - 9,00ccm / (0.15 - 0.55cu.i) Flug 3,50 - 9,95 ccm / (0.21 - 0.61cu.i) Heli 4,90 - 9,95ccm / (0.30 - 0.61cu.i) | 10 - 16% Nitro |
| 500905107 | Glühkerze Jets No.7 Kalt | Car 3,50 - 9,00ccm / (0.21 - 0.55cu.i) Flug 1,80 - 3,50ccm / (0.11 - 0.21cu.i) Heli 4,90 - 9,95ccm / (0.30 - 0.61cu.i) | 15 - 25 % Nitro |
| 500905108 | Glühkerze Jets No.8 Sehr Kalt | Car 3,50 - 5,90ccm (0.21cu.i - 0.36cu.i) | 15 - 25 % Nitro |
| 500905109 | Glühkerze Jets No.9 Extra Kalt | Car 3,50 - 5,90ccm (0.21cu.i - 0.36cu.i) | 15 - 25 % Nitro |
| 500905110 | Glühkerze Jets 4-Takt | Nur 4-Takt Motoren Only 4-Stroke Engines | - |

Nitro Zubehör / Nitro Accessories

500905063



Akku-Glühkerzenstecker 2500 mAh NiMH
Battery glow plug igniter 2500 mAh NiMH

500013117



Ladekabel für Glühkerzenstecker
Charging cable for glow plug igniters

500608104



Empfängerakkupack 6V/1600 mAh NiMH
Receiver battery pack 6V/1600 mAh NiMH

500905036



Silikonkraftstoffschlauch Länge: 1m, Innen-
Ø: 3mm, Außen-Ø: 5mm / Silicone fuel hose
length: 1m, Inner-Ø: 3mm, Outer-Ø: 5mm

500905193



Luftfilteröl 50 ml
Air Filter Oil

500905194



Afterrunöl 50 ml
After Run Oil

500905061



Akku-/Glühkerzenstecker set 230 V mit
integriertem 2500 mAh NiMH-Akku; 600 mA
Ladestrom / Battery/glow plug igniter set, 230 V

500906128



Micro Fail-Safe wasserdicht, Betriebsspannung
4,8-6 V, J/R-Servoanschlusskabel / Micro Fail-
Safe water proof, Operating voltage 4,8-6 V

500105141



Luftfilter-Set 1:10
Air filter set 1:10

500905070



Auspuff Chrom
Power Pipe chrom 1:10

500905071



Auspuff Chrom
Powerpipe chrom 1:8

500902078



Krümmerrichtung, 5 Stück
Manifold sealing, 5 pcs.

500205493



Luftfilter 1:8
Air filter 1:8

500905078



Tankfüllflasche 300 ml
Fuel bottle 300 ml

500013306



Tankfüllflasche 500 ml
Fuel bottle 500 ml

500905701



Kupplungsglocke 13 Z
Clutch bell 13 Z

500905702



Kupplungsglocke 14 Z
Clutch bell 14 Z

500905703



Kupplungsglocke 15 Z
Clutch bell 15 Z

500905118



1:8 Luftfilter Schaumstoff
1:8 Airfilter foam

500905098



1:8 Pro Aluminium Luftfilter
1:8 Pro Aluminium airfilter

500905115



1:10 Luftfilter-Set
1:10 air filter set

500905116



1:8 Luftfilter-Set
1:8 air filter set

500908143

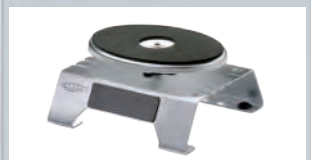

Montageständer f.1:10/1:8 (Aluminium)
Car stand 1:10/1:8 (Aluminium)

500905065



Glühkerzenschlüssel
Glow plug spanner

500054648



Force Seilzugstarter ohne Flansch
Pullstart

500606083



Expert Charger GP 500mAh

500905082 Nitroset / Nitroset

Die ideale Erstausrüstung für den Verbrennerfahrer. Inhalt: Tankflasche 350 ccm, Glühkerzenschlüssel SW 8/9/10/12/17, Radmutterenschlüssel SW 4/4,5/5,5/7, Glühkerzenstecker mit Akku 2500 mAh NiMH, entsprechendes Ladegerät mit 600 mA Ladestrom und je einen Kreuz- und Längsschlitz-Schraubendreher.

The perfect starter kit for drivers of combustion cars. Contents: 350 ccm fuel bottle, glowplug wrench SW 8/9/10/12/17, wheel nut wrench SW 4/4,5/5,5/7, glowplug socket with 2500 mAh NiMH battery, appropriate charger with 600 mA charging current and flat-head and cross-head screwdrivers.





EXPERT CHARGER STATION

10A

CE FC

Made in China

Charge Current: CARSON Expert Charger

Charge Power Limited: 0.1-10A 20W

Lithium Battery Cell Count: 1-6 Cells

Esc Mode

Dec.

Inc.

Start/Enter

CARSON LIPo-AKKU 7.4V 6000mAh

CARSON LIPo-AKKU 7.4V 6000mAh

Steckerlader / Plug Charger

500606081

500 mAh

Delta-Peak Abschaltung



Expert Charger NIMH 500mAh

500606072

1A Ladestrom

Delta-Peak Abschaltung



Expert Charger NIMH 1A

500606083

500 mAh

Delta-Peak Abschaltung



Expert Charger GP 500mAh

500606069

2A Ladestrom

Delta-Peak Abschaltung



Expert Charger NiMH Compact 2A

500606070

4A Ladestrom

Delta-Peak Abschaltung



Expert Charger NiMH Compact 4A

Delta-Peak Abschaltung

Bei einer Delta Peak Abschaltung erkennt das Ladegerät den Ladezustand des Akkus und beendet den abgeschlossenen Ladevorgang automatisch.

With delta peak cut-out, the charger detects the state of charge of the power pack and automatically stops when charging is complete.

| Art.-Nr./N° | Bezeichnung / Description | Version für / version for | Eingang / input | Ladestrom / charging rate | Abschaltung / cutoff | Stecker / connector |
|-------------|--------------------------------|---------------------------|-----------------|---------------------------|----------------------|-----------------------------------|
| 500606069 | Expert Charger NiMH Compact 2A | 6 Zellen / 6 cell | 230 V | 2A | Delta Peak | TAMIYA |
| 500606070 | Expert Charger NiMH Compact 4A | 6 Zellen / 6 cell | 100-240 V | 4A | Delta Peak | TAMIYA |
| 500606072 | Expert Charger NiMH 1A | 6 Zellen / 6 cell | 100-240 V | 1000 mAh | Delta Peak | TAMIYA |
| 500606081 | Expert Charger NiMH 500mAh | 6 Zellen / 6 cell | 100-240 V | 500 mAh | Delta Peak | TAMIYA |
| 500606083 | Expert Charger GP 500mAh | 6 Zellen / 6 cell | 100-240 V | 500 mAh | Delta Peak | Glühkerzenstecker und BEC-Stecker |

Ladesets NiMH / Charger Sets NiMH

500607017

2A/500 mAh

Delta-Peak Abschaltung



Expert Charger Car & Radio Set

Lieferumfang: Expert Charger Car & Radio 2A 500mAh, 7,2V Akku 3000mAh, 4x Mignon Akku 1,2V 2100 mAh, Ladeschale.

Scope of delivery: Expert Charger Car & Radio 2A 500mAh, 7,2V Akku 3000mAh, 4x Mignon Akku 1,2V 2100 mAh, Charging Case.

500607013

4A Ladestrom

Delta-Peak Abschaltung



Expert Charger NiMH Compact 4A Lade Set

Lieferumfang: Ladegerät, Netzkabel, Anleitung.

Scope of delivery: Charger, power cord, manual.

Lieferumfang: Ladegerät EXPERT CHARGER LiPo-Compact V2, Handbuch DEU / ENG

Scope of delivery: EXPERT CHARGER LiPo-Compact V2, GER/ENG manual.

500906070



LiPo Safety Bag Ladesack /
LiPo safety charging bag

N° 500606063
Expert Charger LiPo Compact/V2



800 mAh Ladestrom

- Schnellladegerät / Quick charger
- Für alle 7,4 V und 11,1 V LiPo-Akkus (2S/3S) / for all 7.4 V and 11.1 V LiPo batteries (2S/3S)
- Schonendes Laden durch Balancer-Funktion / Save charging by balancer function
- Ladestrom 800 mA / Charging current 800 mA
- Balancer-Stecksystem XHP / Balancer XHP plug system

Eingangsspannung: 100-240 V, 50/60 Hz (AC)
Ladestrom: 800 mA
Akkutypen: 2S/3S LiPo (7,4-11,1 V) integrierter Balancer + XHP Stecksystem

Input voltage: 100-240 V, 50-60 Hz (AC)
Charging current: 800 mA
Battery types: 2S/3S LiPo (7.4-11.1 V) Balancer + HP plug system

Lieferumfang: Ladegerät EXPERT CHARGER LiPo-Compact 3A, Handbuch DEU / ENG

Scope of delivery: EXPERT CHARGER LiPo-Compact 3A, GER/ENG manual.

500906070



LiPo Safety Bag Ladesack /
LiPo safety charging bag

N° 500606069
Expert Charger NiMH Compact 2A



2A Ladestrom Version

3A Ladestrom Version

Eingangsspannung: 110-240 VAC
Maximaler Ladestrom: 3A
Akkutyp: LiPo
Zellenzahl: 2, 3 oder 4 Zellen
Gewicht: 175g

Input voltage: 110-240 VAC
Maximum charging current: 3A
Type of battery: LiPo
Number of cells: 2, 3 oder 4 Zellen
Weight: 175g

Lieferumfang: Ladegerät EXPERT CHARGER for Beginner, Ladekabel T-Plug, Ladekabel TAMIYA-Plug, Handbuch DEU / ENG.

Scope of delivery: EXPERT CHARGER, for beginner, T-Plug charging cable, TAMIYA-Plug charging cable, GER/ENG manual.



N° 500606064
Ladegerät Beginner 1/3/5A 2-3S/1-8Z 230V



1-5A Ladestrom / 50 W

Eingangsspannung Netzteil: 100-240 V, 50/60 Hz (AC)
Ladestrom: 1,0 A / 2,0 A / 5,0 A / max. 50 W
Akkutypen: 2S/3S Li-xx (7,4-11,1 V), 1-8 Zellen NiMH (1,2-9,6 V) integrierter Balancer + XHP Stecksystem
Gewicht: 490 g
Größe: 110x109x49 mm

Input voltage power supply: 100-240 V, 50-60 Hz (AC)
Charging current: 1.0 A / 2.0 A / 5.0 A / max. 50 W
Battery types: 2S/3S Li-xx (7.4-11.1 V), 1-8 cells NiMH/ NiCd (1.2-9.6 V) Balancer + XHP plug system
Weight: 490 g
Size: 110x109x49 mm

Lieferumfang: Ladegerät EXPERT CHARGER xbase 2.0 se, 12V Netzteil, Balancer-Adapter XHP, Ladekabel T-Plug, 12V Anschlusskabel, Handbuch DEU / ENG.

Scope of delivery: EXPERT CHARGER xbase 2.0 se, 12V power adapter, XHP balancer adapter, T-Plug charging cable, 12V connection cable, GER/ENG manual.



N° 500606053
Expert Charger Xbase 2.0se



35 W

Eingangsspannung: 230 V, 50/60 Hz (AC) oder 11-18 V (DC)
Ladestrom: 0,1 - 4 A
Akkutypen: 1-4 Zellen Li-xx, 1-10 Zellen NiMH/ NiCd, 1-6 Zellen Bleiakku (2-12V), integrierter Balancer + XHP Adapter, Delta-Peak Abschaltung
Gewicht: 175g
Größe: 116x75x25mm

Input voltage: 230 V, 50 Hz (AC) or 12 V (DC)
Charging current: 0,1 - 4 A
Battery types: 1-4 cells Li-xx, 1-10 cells NiMH/ NiCd, 1-6 cells Pb (2-12V) Balancer + XHP Adapter, Delta-Peak cut off
Weight: 175g
Size: 116x75x25mm

Lieferumfang: Ladegerät EXPERT CHARGER All-Rounder 4A, inkl. Tamiya & T-Plug Ladekabel, Anleitung

Scope of delivery: EXPERT CHARGER All-Rounder 4A, incl. Tamiya & T-Plug charging cable, manual.



500906070



LiPo Safety Bag Ladesack /
LiPo safety charging bag

N° 500606088
Expert Charger All-Rounder 4A

Eingangsspannung: 100-240 V 50/60Hz (AC)
Ladestrom: 0,5-4A maximal 30W
Akkutypen: 4-8 Zellen NiMH / 2-4 Zellen Lipo /
LiFe / LiHV

Input voltage: 100-240 V 50/60Hz (AC)
Charging current: 0,5-4A maximum 30W
Battery types: 4-8 cells NiMH / 2-4 cells Lipo / LiFe
/ LiHV

Lieferumfang: Ladegerät EXPERT CHARGER STATION 10A, Balancer-Adapter XHP, Ladekabel T-Plug, Ladekabel TAMIYA-Plug, Handbuch DEU / ENG.

Scope of delivery: EXPERT CHARGER STATION 10A, XHP balancer adapter, T-Plug charging cable, TAMIYA-Plug charging cable, GER/ENG manual.



80 W

500906070



LiPo Safety Bag Ladesack /
LiPo safety charging bag

N° 500606066
Expert Charger Station 10 A 1-6S 12/230V

Eingangsspannung Ladegerät: 100-240 V,
50/60 Hz (AC) / 11-18 V (DC)
Ladestrom: 0,1 - 10 A maximal 80 W
Entladestrom: 0,1 - 2 A maximal 10 W
Akkutypen: 1-6 Zellen Li-xx (7,4-22,2 V), 1-15
Zellen NiMH/ NiCd (1,2-18 V), Bleiakku (2-20
V), integrierter Balancer + XHP Adapter, Delta-
Peak Abschaltung
Gewicht: 640 g
Größe: 145x145x56 mm

Input voltage charger: 100-240 V, 50/60 Hz (AC)
/ 11-18 V (DC)
Charging current: 0.1 - 10 A maximum 80 W
Discharge current: 0.1 - 2 A maximum 10 W
Battery types: 1-6 cells Li-xx (7,4-22,2 V), 1-15
cells NiMh/ NiCd (1,2-18 V), Pb (2-20 V) Balancer
+ XHP Adapter, Delta-Peak cut o
Weight: 640 g
Size: 145x145x56 mm

Lieferumfang: Ladegerät EXPERT CHARGER Pro 100 Watt, Ladekabel T-Plug, Ladekabel Tamiya-Plug, Anleitung.

Scope of delivery: EXPERT CHARGER Pro 100 Watt charging device, T-plug charging cable, Tamiya-plug charging cable, manual.

**NEU
NEW**



500906070



LiPo Safety Bag Ladesack /
LiPo safety charging bag

N° 500606090
Expert Charger Pro 100 Watt

- 100 Watt / 100 watts
- 5 Speicherplätze pro Akku-Typ für eigene Einstellungen / 5 memory locations per battery type for your own settings
- LiPO HV Programm / LiPO HV programme
- Test für Innenwiderstand bei Lithium Akkus möglich / Testing possible for internal resistance with lithium batteries
- Leiser Lüfter / Quiet fan
- Kleines, kompaktes Gehäuse / Small, compact housing Integrated
- Integriertes 220V Netzteil / 220V power supply unit

Lieferumfang: Ladegerät Expert Charger Duo 2.0, Netzkabel, 12 V Anschlusskabel, 2x T-Plug Ladekabel, 2x Balancer-Adapter.

Scope of delivery: Expert Charger Duo 2.0, power cord, 12V connection cable, 2x T-Plug charging cable, 2x balancer adapter.

100 W



500906070



LiPo Safety Bag Ladesack /
LiPo safety charging bag

N° 500608190
Expert Charger Duo 2.0

Eingangsspannung: 11-18V DC oder 230V AC

Ladestrom: max. 6 A je Ausgang

Entladestrom: max. 2 A

Akkutypen: NiMH/NiCd 1-15 Zellen/ Li-xx 1-6 Zellen/ Bleiakku 2-24V, Integrierter Balancer + XHP Adapter je Ausgang, Delta Peak Abschaltung

Digital Mode: (Netzteilfunktion 3-24 V)

Ladung/Entladung: an beiden Ausgängen gleichzeitig möglich

Balancer-Strom: 400 mA

Ladeleistung: max. 50 W je Ausgang

Entladeleistung: max. 5W je Ausgang

Gewicht: 950 g

Größe: 175x150x65 mm

Input voltage charger: 11-18 V DC or 230 V AC

Charging current: 6 A maximum / **Discharge current:** 2 A maximum / **Battery types:** 1-6 cells Li-xx,

1-15 cells NiMH/ NiCd, Pb (2-24 V) Balancer + XHP Adapter, Delta-Peak cut / **Digital Mode:** (Mains unit

function 3-24 V) / **Charge/discharge:** possible on both outputs at the same time / **Balancer current:**

400 mA / **Charge power:** 50 W max. on each output / **Discharge power:** 5W max. on each output

Weight: 950 g / **Size:** 175x150x65 mm

Ladetechnik / Charging Technology

500906003



T-Plug Stecker/ Buchsen 3 Paar
T-Plug Connector set, Content: 3 pairs

500906017



Mini-TAMIYA Stecker / Buchsen 2 Paar
Connector Set Mini, Content: 2 pairs

500906004



T-Plug Buchsen, Inhalt: 5 Stück
T-Plug Sockets, Content: 5 pcs.

500906099



Adapter TAMIYA Stecker auf T-Plug
Charger cable TAMIYA T-plug

500906102



Ladekabel Reflex Wheel Pro
Transmitter charger cable for Reflex Wheel Pro

500906005



T-Plug Stecker 5 Stück
T-Plug Sockets, Content: 5 pcs.

500906105



Adapter T-Plug auf Tamiya-Buchse
Adapter cable T-plug connector/Tamiya socket

500013312



Ladekabel BEC-Stecker
Charger cable BEC

500503028



TAMIYA Ladekabel vergoldet
Charger cable TAMIYA golden

500013603



Stecker / Buchse TAMIYA 2 Paar
TAMIYA-connectors und -sockets, Content: 2 pair

500906002



Adapterkabel TamTech auf Tamiya
Adapter cable Tamiya - TamTech

500906081



Ladekabel T-Plug
Charger cable T-Plug

500906084



Goldkontakte 4 mm 2x Buchse, 2x Stecker
Gold contacts 4 mm

500906016



Adapterkabel Mini TAMIYA / TAMIYA
Charger cable Mini-TAMIYA

500013117



Ladekabel für Akku-Glühkerzenstecker
Charger cable for glow plug heater

500906144



Balancer Extensions Set (2S / 3S) 200mm (2)
Balancer-Extension-cable set (2S / 3S LiPoAkkus)

Nitro Lader & Akkus / Nitro Chargers & Batteries

500606083

500 mAh
Delta-Peak Abschaltung



Expert Charger GP 500mAh

500608104



Empfängerakkupack 6V/1600 mAh NiMH
Receiver battery pack 6V/1600 mAh NiMH

500503033



Batteriebox 4xAA
Battery Box 4xAA

500905063



Akku-Glühkerzenstecker 2500 mAh NiMH
Battery glow plug igniter 2500 mAh NiMH

Batterien / Batteries, single cells

500609045



9 Volt-Block Alkaline Batterie
Nicht wiederaufladbar / Not rechargeable

500609044



Micro-Set Alkaline Batterien 1,5 V
Nicht wiederaufladbar / Not rechargeable

500609042



Mignon-Set NiMH Akku 1,2 V/2100 mAh
Wiederaufladbar / Rechargeable

500609046



Batterie Set Baby/C 1,5V (2)
Nicht wiederaufladbar / Not rechargeable

500609043



Mignon-Set Alkaline Batterien 1,5 V
Nicht wiederaufladbar / Not rechargeable

500609040



Micro-Set NiMH Akku 1,2 V/800 mAh
Wiederaufladbar / Rechargeable

500609047



Batterie Set Mono/D 1,5V (2)
Nicht wiederaufladbar / Not rechargeable

500609050



Batterie Box Mignon/AA 1,5V (20)
Nicht wiederaufladbar / Not rechargeable

NiMH Akkupacks / NiMH battery packs

500608158



Racing Pack 2100mAh, NiMH 7,2V

500608212



Akku Racing Pack 7,2V/2500mAh NiMH
Battery Racing Pack 7,2V/2500mAh NiMH

500608117



Akku Pack 7,2 V/3000 mAh NiMH (T-Plug)
Battery Pack 7,2 V/3000 mAh NiMH (T-Plug)

500608213



Akku Racing Pack 7,2V/3200mAh NiMH
Battery Racing Pack 7,2V/3200mAh NiMH

500608024



Racing Pack 7,2 V/3500 mAh NiMH
Tamiya-Stecker / Tamiya connector

500608077



Racing Pack 7,2 V/4500 mAh NiMH
Tamiya-Stecker / Tamiya connector

500608097



Racing Pack 7,2 V/2700 mAh NiMH
Für Sand Scorcher / for Sand Scorcher

500608028



Akku Power Pack FD 9,6 V/1300 mAh NiMH
Tamiya-Stecker / Tamiya connector

500608184



Akku Power Pack 9,6 V/2100 mAh
Tamiya-Stecker / Tamiya connector

500608104



Akkupack Empfänger 6V/1600 mAh NiMH
Der Pack besteht aus fünf 2/3AA-Zellen. Mit BEC-Steckersystem. / The pack consists of 2/3AA cells. With BEC connector system.

500608159



Akkupack Empfänger 6V,1600mAh,NiMH/Hump

500608143



NiMH-RX-Pack-6V-SubC3000mAh-TAM/JR

500608103



Akku Racing Pack 7,2V/1400 mAh NiMH Mini Tamiya
Mini Tamiya-Stecker / Mini Tamiya connector

NiMH Akkupacks / NiMH battery packs

500608221



7,2V/1800mAh NiMH Race Akku TAM
7,2V/1800mAh NiMH Race Battery TAM

500608222



7,2V/2500mAh NiMH Race Akku TAM
7,2V/2500mAh NiMH Race Battery TAM

500608224



7,2V/3000mAh NiMH Race Akku TAM
7,2V/3000mAh NiMH Race Battery TAM

500608225



7,2V/4000mAh NiMH Race Akku TAM
7,2V/4000mAh NiMH Race Battery TAM

500608228



7,2V/4800mAh NiMH Race Akku TAM
7,2V/4800mAh NiMH Race Battery TAM

500608229



9,6V/1500mAh NiMH Power Akku TAM
9,6V/1500mAh NiMH Power Battery TAM

500608230



6V/1800mAh NiMH Empfängerakku Hump BEC
Rec. Battery 6V/1800mAh NiMH BEC Plug

LiPo 7,4 V Akkus für 2S und 4S Modelle

LiPo batteries for 2S and 4S Models

500608098



LiPo-RP-7.4V-3400mAh-40C-Round-T-Plug

500608145



LiPo-RP-7.4V-4000mAh-25C-Round-T-Plug

500608136



LiPo-RP-7.4V-5000mAh-30C-Box-4mm

LiPo 11,1V Akkus für 3S und 6S Modelle

LiPo batteries for 3S and 6S Models

500608102



LiPo Akku / LiPo battery 11,1 V/3100 mAh
T-Plug-Stecker / T-plug connector

Li-Ion Akku für 1:10 RTR Modelle

Li-Ion batteries for 1:10 RTR Models

500608152



Li-Ion Akku 7,4V/ 2200mAh



500906070

CARSON LiPo Safety Bag Ladesack / LiPo safety charging bag

Der LiPo Safety Bag ist zur sicheren Aufbewahrung, zum sicheren Transport und als Schutz während des Ladevorgangs von LiPo Akkus gedacht. Er ist aus einem feuerhemmenden Material.

Der Safety Bag entbindet Benutzer NICHT ihrer Aufsichts- und Sorgfaltspflicht! LiPo Akkus dürfen nur unter Aufsicht auf feuerfesten Unterlagen geladen werden.

The Safety Bag is intended for safe storage, for safe transport and as protection during the charging of LiPo batteries. It is made from a fireproof material.

The Safety Bag does NOT release users from their obligation to exercise due care and attention! LiPo batteries may only be charged on a fireproof base under supervision.

LiPo Akkupacks / LiPo battery packs

500608231



7,4V/3600mAh 60C LiPO Race Akku T-Pl. HC R
7,4V/3600mAh 60C LiPO Race Battery T-Pl. HC R

500608232



7,4V/4500mAh 60C LiPO Race Akku T-Pl. HC R
7,4V/4500mAh 60C LiPO Race Battery T-Pl. HC R

500608233



7,4V/4200mAh 60C LiPO Race Akku T-Pl. HC
7,4V/4200mAh 60C LiPO Race Battery T-Pl. HC

500608234



7,4V/5400mAh 60C LiPO Race Akku T-Pl. HC
7,4V/5400mAh 60C LiPO Race Battery T-Pl. HC

500608235



11,1V/4200mAh 60C LiPO Race Akku T-Pl. HC
11,1V/4200mAh 60C LiPO Race Battery T-Pl. HC



1:10 Vorbildgetreue Reifensätze On-Road / 1:10 Scale Wheel Sets On-Road

500900533



GT Style silber
GT style silver

500900539



F12 Style schwarz
F12 style black

500900540



VINS Style schwarz
VINS style black

500900543



6S Style schwarz
6S style black

500900545



AMC Style chrom/schwarz
AMC style chrome/black

500900551



Classic Style chrom/gold
Classic style chrome/gold

500900552



Rat Style silber
Rat style silver

500900084



Big Wheel Set 1 schwarz-chrom
Big Wheel Set 1 black-chrome

500900064



Big Wheel Set On-Road 13 weiß-chrome
Big Wheel Set On-Road 13 white-chrome

500900080



Big Wheel Set 2 schwarz-chrom
Big Wheel Set 2 black-chrome



1:10 Touring Reifensätze On-Road / 1:10 Touring Wheel Sets On-Road

500900156



1:10 Räderset Y-Design1 (4) silber/rot
1:10 Wheel Set Y-Design1 (4) silver/red



500900157



1:10 Räderset Y-Design1 (4) schwarz/rot
1:10 Wheel Set Y-Design1 (4) black/red



500900158



1:10 Räderset Y-Design1 (4) schw./chrom
1:10 Wheel Set Y-Design1 (4) bl./chrome



500900159



1:10 Räderset Y-Design1 (4) chrom
1:10 Wheel Set Y-Design1 (4) chrome



500900160



1:10 Räderset 10 Sp. Design (4) silber
1:10 Wheel Set 10 sp. Design (4) silver



500900161



1:10 Räderset 10 Sp. Design (4) rauch/ch.
1:10 Wheel Set 10 sp. Design (4) smoke



500900162



1:10 Räderset Y-Design2 (4) schw./chrom
1:10 Wheel Set Y-Design2 (4) bl./chrome



500900163



1:10 Räderset Y-Design2 (4) gold/chrom
1:10 Wheel Set Y-Design2 (4) gold/chrome



500900164



1:10 Räderset M-Design (4) chrom
1:10 Wheel Set M-Design (4) chrome



500900165



1:10 Räderset 5 Sp.-Design (4) schw./w.
1:10 Wheel Set 5 sp. Design (4) black/wh



500900166



1:10 Räderset 5 Sp.-Design (4) silber
1:10 Wheel Set 5 spoke Design (4) silver



500900167



1:10 Räderset 5 Sp.-Design (4) blau/schw
1:10 Wheel Set 5 sp. Design (4) blue/bl



1:10 Reifensätze Buggy 2WD / 1:10 Wheel Sets Buggy 2WD

500900134

1:10
2WD



All Terrain 2WD Reifen-Set (4)
All Terrain 2WD wheel set (4)

500900137

1:10
2WD



X10EB Reifen-Set Stunt Warrior 2WD
X10EB wheel set Stunt Warrior 2WD

500900027

1:10
2WD



„All Terrain“ Reifen-Set (4 Stück), Felgen schwarz 2WD /
"All Terrain" wheel set (4 pcs.), Rims black 2WD

500900028

1:10
2WD



„All Terrain“ Reifen-Set (4 Stück), Felgen chrom 2WD /
"All Terrain" wheel set (4 pcs.), Rims chrome 2WD

500900155

1:10
4WD



**NEU
NEW**

1:10 2WD Paddle Reifenset (4) Neon gelb
1:10 2WD Paddle Wheel Set (4) Neon yellow

1:10 Reifensätze Buggy 4WD / 1:10 Wheel Sets Buggy 4WD

500900135

1:10
4WD



Super Gripp 4WD Reifen-Set (4)
Super Gripp 4WD wheel set (4)

500900136

1:10
4WD



All Terrain 4WD Reifen-Set (4)
All Terrain 4WD wheel set (4)

500105200

1:10
4WD



On-Road Reifen-/Felgen Set Ø 83 mm 4WD
On-Road Tyre/rim set Ø 83 mm 4WD

500900099

1:10
4WD



Reifen-Felgenset Dirt Warrior Ø 83 mm 4WD
Tyre/rim set Ø 83 mm 4WD

500900612

1:10
4WD



Reifenset Desert Buggy 4WD
Tyre set Desert Buggy 4WD



1:10 Touring Reifensätze On-Road / 1:10 Touring Wheel Sets On-Road

500900047

1:10

4WD



Off-Road Ø ca. 105 mm
Off-Road Ø about 105 mm

500900049

1:10

4WD



Off-Road Ø ca. 105 mm
Off-Road Ø about 105 mm

500900113

1:10

4WD



Off-Road "Desert Warrior" Ø ca. 105 mm
Off-Road "Desert Warrior" Ø about 105 mm



1:10 Reifensätze Monstertruck / 1:10 Wheel Sets Monstertruck



500900140



Buggy-Reifen All Terrain hinten 38mm (2)
Buggy-Tires All Terrain rear 38mm (2)

1:8 Reifensätze Off-Road Buggy / 1:8 Wheel Sets Off-Road Buggy

500900098



High Speed Reifen-/Felgen-Set (verstärkt) Ø 115 mm / High speed tyre/rim set (reinforced) Ø 115 mm

500900062



Beach Reifen-/Felgen-Set Ø 115 mm
Beach tyre/rim set Ø 115 mm

1:8 Reifensätze / 1:8 Wheel Sets On-Road Buggy

500900076



On-Road Reifen-/Felgen-Set Ø 100 mm
On-Road tyre/rim set Ø 100 mm

500405840



Reifen-Set Buggy Street 4S
Tyre set Buggy street 4S

500405841



Reifen-Set Buggy Street 6S
Tyre set Buggy street 6S

500900138



Reifen-Set X10ET Beat Warrior
Tyre set X10ET Beat Warrior





CARSON

4
for

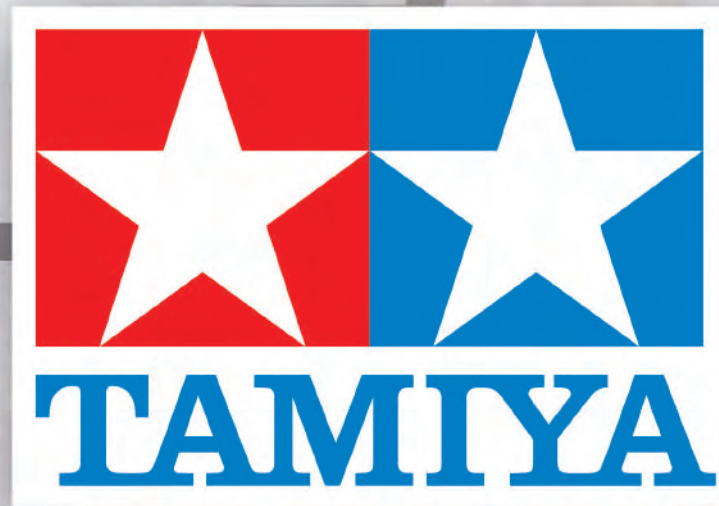

Auflieger / Semitrailer



N° 500907334

1:14 20Ft. Container Auflieger-Fahrg.Kit / 1:14 20Ft. Semitrailer for Container Kit



N° 500907335

1:14 20Ft. Sea-Container Kit / 1:14 20Ft. Sea-Container Kit

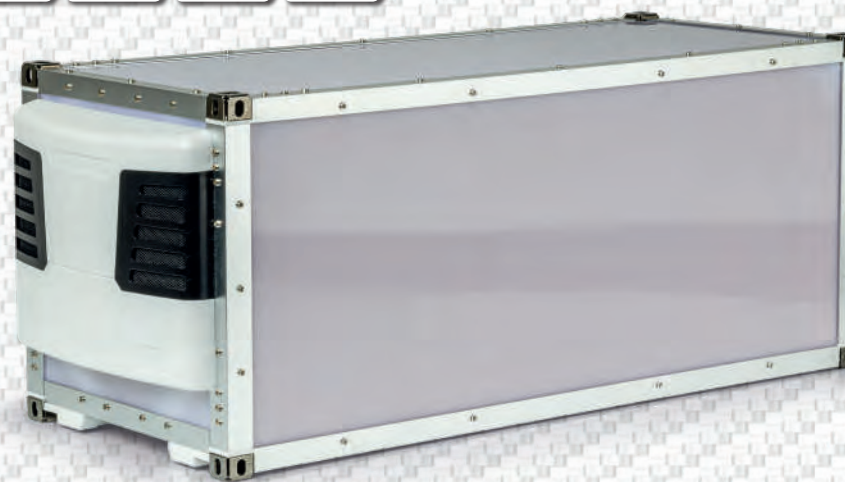

N° 500907336

1:14 20Ft. Kühlcontainer Kit / 1:14 20Ft. Refrigerated Container Kit

Auflieger / Semitrailer



- Alu Rahmen CNC gefräßt (schwarz eloxiert) / Aluminium frame CNC-milled (anodised black)
- Pendelachsenaufhängung mit Blattfedern / Swing axle suspension with Flat springs
- Felgen mit Breitreifen (verchromt) / Rims with wide-base tyres (chrome-plated)
- mechanische Sattelstützen / mechanical seat posts
- Reifen mit Schaumstoffeinlagen / Tyres with foam inserts
- passender Leuchtensatz 300056502 / suitable lamp set 300056502
- Containerbefestigung änderbar / Container fastening changeable



N° 500907348

1:14 Auflieger-Fahrgestell 20/40ft.Cont. /
1:14 Trailer Chassis 20/40ft.Cont.



- Nachbildung eines Flüssigkeitscontainers / Replica of a liquid container
- Edelstahl Rohr / Stainless steel pipe
- Alu Rahmen CNC gefräßt (schwarz eloxiert) / Aluminium frame CNC-milled (anodised black)
- Verriegelung am Chassis erfolgt über Twist-Locks / locking to the chassis via twist-locks
- passend für 2 Achs Container Auflieger 500907334 und 500907348 / suitable for a 2 axle container semi-trailer 500907334 and 500907348
- Container Gewicht 4.430g / Container weight 4,430g



N° 500907349

1:14 20ft. Flüssigkeitscontainer / 1:14 20ft. Liquidcontainer

Truck Zubehör / Trailer Accessories

500530902



1:14 Truck Alu Aufhängung 3-Achser/hinten
1:14 Alum. Rear Suspension Mount Set

500530903



1:14 Truck Alu Vorderachse gefräst
1:14 Alum. Front Axle CNC drilled

500530907



1:14 Truck Alu Felge 9-Loch US-Style vorn/
mitlaufend (2) / 1:14 Alum. Front Wheel
9-Holes US-Style BB (2)

500530908



1:14 Truck Alu Felge 9-Loch hinten/ange-
trieben (2) / 1:14 Alum. Rear Wheel 9-Holes
rear/12mm Hex (2)

500530910



1:14 Alu Rahmentraverse m. Lufttank (2)
1:14 Alum. Middle Chassis Mount Truck(2)

500530913



1:14 Aluminium Radachsen für Vorderachse (2)
1:14 Aluminium Front Knuckle Arms (2)

500530914



1:14 Aluminium Halterung Lenkhebel 2/3 Achs EU
1:14 Aluminium Steering Assem.Set EU 2/3 Axle

500530918



1:14 Truck Alu Sattelkupplung n. MFC
1:14 Truck Alum. Coupler Plate n. MFC

500530927



TA01/DF01 Alu Zentralwelle 4WD
TA01/DF01 Alum. Center Drive Shaft 4WD

500530929



TT02B 12mm Alu Felgenmitn. Br. 9mm (2)
TT02B Alum. Hex Adapter 12x9mm (2)

Brushless Sets 1:10 / Brushless Sets 1/10



Dragster³ Brushless



WASSERFEST
WATER RESISTANT

Diese Brushless Sets sind entwickelt worden, um auch bei nassen, feuchten Bedingungen fahren zu können (Pfützen und Regen). Fahrzeug und Komponenten dürfen jedoch nicht unter Wasser getaucht werden. Bitte unbedingt Hinweise in der Bedienungsanleitung beachten!

This brushless kits are designed, to it can be driven in wet conditions (puddles and rain). Vehicle and components shall not be submerged under water. Please pay attention to the notes contained in manual.

| Brushless Combo DRAGSTER 3 water resistant inkl./incl. Set-Up Box | | |
|---|----------------------|----------------------|
| Art.-Nr./N° | 500906246 | 500906247 |
| DRAGSTER 3 Motor sensorlos / sensorless | | |
| Windungen / Turns | 16T OnRoad/OffRoad | 18T OnRoad/OffRoad |
| kV | 2500 kV | 2000 kV |
| Eingang / Input | 6-8 NiMH / 2-3S LiPo | 6-8 NiMH / 2-3S LiPo |
| U/min bei 7,4 V / RPM at 7.4V | 18.500 | 14.800 |
| Geschwindigkeit OnRoad Chassis 1/10 / Speed | < 45 km/h | < 35 km/h |
| Dauerstrom / Continuous current | 38 A | 31 A |
| Abgabeleistung / Output | 280 W | 230 W |
| Maße / Size (D x L) | 36 x 53 mm | 36 x 53 mm |
| Shaft length | 13 mm | 13 mm |
| Shaft diameter | 3,175 mm | 3,175 mm |
| Gewicht / Weight | 175 g | 175 g |
| DRAGSTER 3 Brushlessregler / Brushless Controller | | |
| Eingang / Input | 6-8 NiMH / 2-3S LiPo | 6-8 NiMH / 2-3S LiPo |
| Dauerstrom / Continuous current | 100 A | 100 A |
| kurzzeitig / Peak current | 180 A | 180 A |
| Taktung / Clock speed | 16 kHz | 16 kHz |
| Gewicht m. Kabel / Weight | 90 g | 90 g |

500906246



Brushless-Set Dragster 3 - 16T

500906247



Brushless-Set Dragster 3 - 18T



Turnsgravur am Gehäuse /
Turns engraving on housing



Turnsgravur an Welle /
Turns engraving on shaft



Motor-Steckersystem /
Turns engraving on shaft



LCD Programmierbox enthalten /
LCD programm box included



OneTouch ein- und Ausschalter /
One touch on/off switch



Neueste Technik mit sehr feinem Reglerverhalten /
New technologie with finest performance

DT-03 Ersatz- & Tuningteile / DT-03 Spare & Hop Up Parts

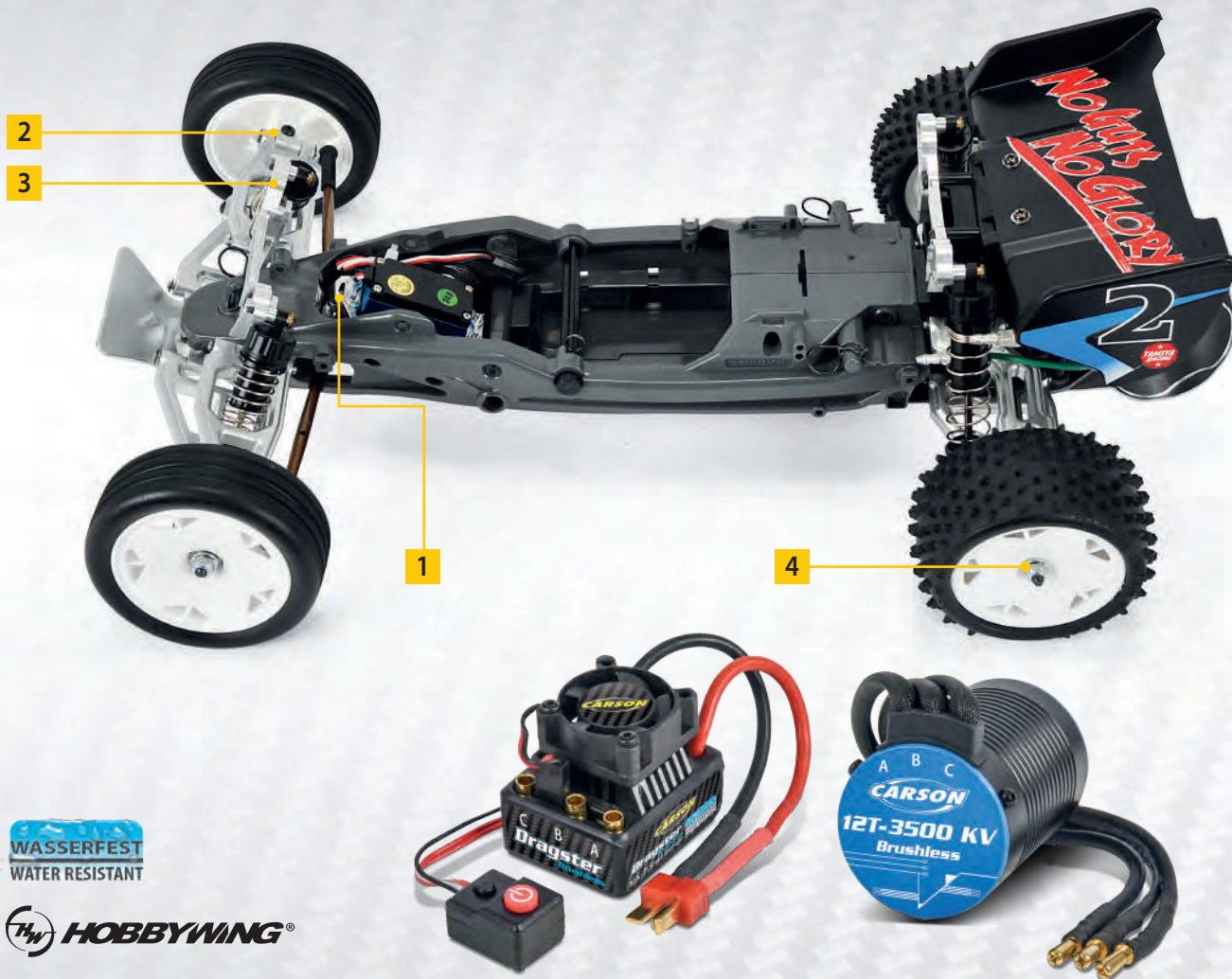

WASSERFEST
WATER RESISTANT



On-Road Version
für TAMIYA Regler TBLE-02S und TBLE-03S



Off-Road Version
für TAMIYA Regler TBLE-02S und TBLE-03S



Brushless-Set Fahrregler & Motoren Combo / Brushless-Set ESC & Motors *

| Art.-Nr./N° | Bezeichnung/Description | Turns | Maße / Size (ØxL) | kV | U/Min./RPM (7,2V) | Leistung / Power | Dauerstrom Continuous current |
|-------------|----------------------------|-------|-------------------|---------|-------------------|------------------|----------------------------------|
| 500906273 | Brushless Set DRAGSTER 8T | 8 | 36 x 55 mm | 4500 kV | 33.000 | 450 W | 63 A |
| 500906274 | Brushless Set DRAGSTER 12T | 12 | 36 x 55 mm | 3500 kV | 25.000 | 350 W | 50 A |
| 500906275 | Brushless Set DRAGSTER 14T | 14 | 36 x 55 mm | 3000 kV | 21.000 | 300 W | 45 A |

Fahrregler / ESC*

| Funktion / function | Zellen NiMH cells NiMH | Zellen LiPo cells LiPo | Stromabgabe kurz peak current | Stromabgabe lang continuous current | Taktfrequenz Clock speed | Gewicht weight | Stecksystem plug system |
|--|---------------------------|---------------------------|----------------------------------|--|-----------------------------|-------------------|----------------------------|
| Vorwärts / Bremse / Rückwärts forward / stop / backward | 6-7 | 2 | 160 A | 100 A | 16 kHz | 86 g | T-Plug |

DT-03 Ersatz- & Tuningteile / DT-03 Spare & Hop Up Parts

500900134

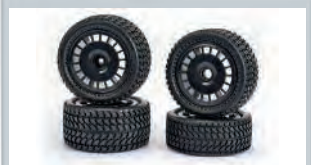

All Terrain 2WD Reifen-Set (4)
All Terrain 2WD wheel set (4)

500900027



Buggy-Reifen/Felgen-Set All Terrain schwarz (2+2) / Buggy-Tire/Wheel Set All Terrain black (2+2)

500900028



Buggy-Reifen/Felgen-Set All Terrain Chrom (2+2) / Buggy-Tire/Wheel Set All Terrain Chrome (2+2)

500900137



X10EB Reifen-Set Stunt Warrior 2WD
X10EB wheel set Stunt Warrior 2WD

500906052



Fighter Cup Elektromotor Cup Machine
Fighter Cup Electric Motor Cup Machine

500906235



LED Lichterset TAMIYA
LED Light set TAMIYA

500904054



Kugellagerset TT-01/TT-01E/TT-02B
Ball bearing set TT-01/TT-01E/TT-02B

500013407



Stahl-Motorritzel 17Z M0.8
Steel Pinion Gear 17T M0.8

500013409



Stahl-Motorritzel 19Z M0.8
Steel Pinion Gear 19T M0.8

500904055



Kugellagerset TT-02 On-Road Chassis
Ball bearing set TT-02 On-Road Chassis

500530026



TT-01/TT01E Alu Öldämpfer 50 mm (2)
TT-01/TT-01E Alum. Oil-Damper 50 mm (2)

500530003



TT-01/TT-01E Alu Felgenmitnehmer 12 mm (4) / TT-01/TT-01E Alum. Wheel Hex Drive Adaptor (4)

500530010

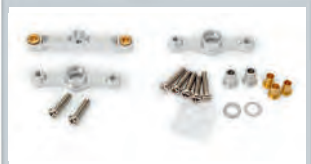

TT-01 Alu Lenkung komplett
TT-01 Alum. Steering Assembly Set

500530020

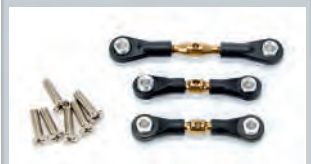

TT-01/TT-01E Spurstangen-Set einstellbar (3) / TT-01/TT-01E Alum. Tie Rod - Set (3)

500530819



DT03 Alu Felgenmitnehmer vorn (2) mitlaufend / DT03 Alum. 12mm Hex Drive Washer (2) Ball bearing



On-Road Version

für TAMIYA Regler TBLE-02S und TBLE-03S

500906258



BL Motor 11,5T sens. Dragster-Pro OR inkl. Sensorkabel / BL Motor 11,5T sens. Dragster-Pro OR incl. sensor cable



Off-Road Version

für TAMIYA Regler TBLE-02S und TBLE-03S

500906260



BL Motor 10,5T sens. Dragster-Pro OF inkl. Sensorkabel / BL Motor 10,5T sens. Dragster-Pro OF incl. sensor cable

500906197



Elektromotor 540 Black Race Machine
Electric engine 540 Black Race Machine

500906264



Fahrregler Dragster Brushed 70A
Speed Controller Dragster Brushed 70A

Tuningsätze / Tuning sets

Lieferumfang: Motorritzel (28 Zähne), TT-01 Speed Getriebe (55/58 Z), Öldruckstoßdämpfer-Set (4 Stück), Kugellagersatz (16 Stück)

Scope of delivery: Pinion Gear (28T), TT-01 Speed gear set (55/58T), Oil shock absorber set (4 pieces), Ball bearing set (16 pieces)



- Kontrolliertere Lenkmanöver / *More controlled manoeuvrability*
- Höhere Geschwindigkeit / *Higher Speed*
- Längere Fahrzeit / *Longer running time*
- Bessere Straßenlage / *Better roadability*
- Geringerer Stromverbrauch / *Lower consumption*
- Reduzierter Reifenverschleiß / *Reduced tyre abrasion*

N° 500908123

Tuningsatz TT-01 / TT-01E / Tuning set TT-01 / TT-01E

Lieferumfang: Motorritzel (25 Zähne), TT-02 Speed Getriebe (68 Z), Öldruckstoßdämpfer-Set (4 Stück), Kugellagersatz (16 Stück)

Scope of delivery: Pinion Gear (25T), TT-02 Speed gear set (68T), Oil shock absorber set (4 pieces), Ball bearing set (16 pieces)

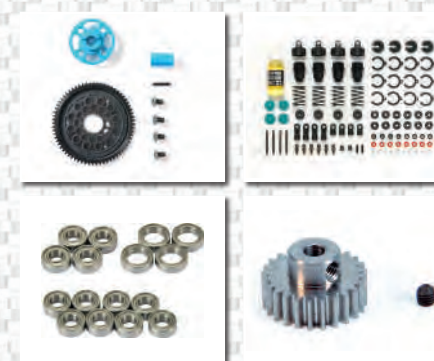

- Kontrolliertere Lenkmanöver / *More controlled manoeuvrability*
- Höhere Geschwindigkeit / *Higher Speed*
- Längere Fahrzeit / *Longer running time*
- Bessere Straßenlage / *Better roadability*
- Geringerer Stromverbrauch / *Lower consumption*
- Reduzierter Reifenverschleiß / *Reduced tyre abrasion*

N° 500908234

Tuningsatz TT-02 / Tuning set TT-02



| Kugellager-Set im Röhrchen (10 Stück) / ball bearing-Set in the tube (10 pcs.) | | | |
|--|----------------------|----------------------|----------------|
| N° | Innen-Ø / Inner Ø mm | Außen-Ø / Outer Ø mm | Breite / Width |
| 500904001 | 3 | 6 | 2,5 |
| 500904002 | 3 | 7 | 3 |
| 500904004 | 4 | 8 | 3 |
| 500904005 | 4 | 9 | 4 |
| 500904006 | 5 | 8 | 2,5 |
| 500904007 | 5 | 9 | 3 |
| 500904008 | 5 | 10 | 4 |
| 500904009 | 5 | 11 | 4 |
| 500904010 | 6 | 10 | 2,5 |
| 500904011 | 6 | 12 | 4 |
| 500904015 | 8 | 12 | 3,5 |
| 500904016 | 8 | 14 | 4 |
| 500904017 | 8 | 16 | 5 |
| 500904019 | 10 | 15 | 4 |

| Komplette Kugellager-Sätze für TAMIYA/CARSON Fahrzeuge / complete ball bearing sets for TAMIYA/CARSON models | | |
|--|---|-----------------|
| 500904023 | für / for Manta Ray TA01 | 22 Stück / pcs. |
| 500904024 | für / for MO3, FFO2 | 14 Stück / pcs. |
| 500904025 | für / for DT-01 | 10 Stück / pcs. |
| 500904026 | für / for TL-01 | 24 Stück / pcs. |
| 500904027 | für / for Truck, 2 Achsen · axles | 24 Stück / pcs. |
| 500904028 | für / for Truck, 3 Achsen · axles | 30 Stück / pcs. |
| 500904029 | für / for CC-01 | 18 Stück / pcs. |
| 500904030 | für / for TAMIYA Trailer | 8 Stück / pcs. |
| 500904031 | für / for DT-02 / DT-03 | 14 Stück / pcs. |
| 500904054 | für / for TT-01, TT-02 | 16 Stück / pcs. |
| 500904055 | für / for TT-02 | 16 Stück / pcs. |
| 500904053 | für Scania/MAN 3-Achs / for Scania MAN 3-axle | 32 Stück / pcs. |
| 500904054 | Tamiya TT-01/TT-01E | 20 Stück / pcs. |





Zubehör / Accessories



Kugellager-Set im Röhrchen (10 Stück) / ball bearing-Set in the tube (10 pcs.)

| N° | Innen-Ø / Inner Ø mm | Außen-Ø / Outer Ø mm | Breite / Width |
|-----------|----------------------|----------------------|----------------|
| 500904001 | 3 | 6 | 2,5 |
| 500904002 | 3 | 7 | 3 |
| 500904004 | 4 | 8 | 3 |
| 500904005 | 4 | 9 | 4 |
| 500904006 | 5 | 8 | 2,5 |
| 500904007 | 5 | 9 | 3 |
| 500904008 | 5 | 10 | 4 |
| 500904009 | 5 | 11 | 4 |
| 500904010 | 6 | 10 | 2,5 |
| 500904011 | 6 | 12 | 4 |
| 500904015 | 8 | 12 | 3,5 |
| 500904016 | 8 | 14 | 4 |
| 500904017 | 8 | 16 | 5 |
| 500904018 | 8 | 22 | 7 |
| 500904019 | 10 | 15 | 4 |



Modul 0,6 für TAMIYA-Standard Modelle / Modul 0,6 for TAMIYA-Standard Models

| N° | Zähne / Teeth |
|-----------|---------------|
| 500013420 | 12 |
| 500013421 | 13 |
| 500013422 | 14 |
| 500013423 | 15 |
| 500013424 | 16 |
| 500013425 | 17 |
| 500013426 | 18 |
| 500013427 | 19 |
| 500013428 | 20 |
| 500013429 | 21 |
| 500013430 | 22 |
| 500013431 | 23 |
| 500013432 | 24 |
| 500013433 | 25 |
| 500011106 | 26 |
| 500011107 | 27 |
| 500011109 | 29 |



Modul 0,8 für TAMIYA-Off-Road Modelle / Modul 0,8 for TAMIYA-Off-Road Models

| N° | Zähne / Teeth |
|-----------|---------------|
| 500013400 | 10 |
| 500013401 | 11 |
| 500013437 | 12 |
| 500013403 | 13 |
| 500013439 | 14 |
| 500013405 | 15 |
| 500013406 | 16 |
| 500013407 | 17 |
| 500013408 | 18 |
| 500013409 | 19 |



Gehärtete Stahl-Motorritzel Modul 1 für 1:8 Brushlessmodelle / Cured steel pinions modul 1 for 1:8 brushless cars

| N° | Zähne / Teeth |
|-----------|---------------|
| 500906202 | 13 |
| 500906205 | 16 |
| 500906207 | 18 |
| 500906208 | 19 |



Karosseriekammern Je 10 Stück / body braces á 10 pieces

| | |
|-----------|---------------------------|
| 500908058 | 15 mm 1:12 / 1:14 Modelle |
| 500908059 | 20 mm 1:10 Modelle |
| 500908060 | 24 mm 1:10 Modelle |
| 500908062 | 27 mm 1:8 Modelle |
| 500908063 | 34 mm 1:8 / 1:5 Modelle |



Komplette Kugellager-Sätze für TAMIYA Fahrzeuge / complete ball bearing sets for TAMIYA models

| | | |
|-----------|---|-----------------|
| 500904023 | für / for Manta Ray TA01 | 22 Stück / pcs. |
| 500904024 | für / for MO3, FFO2 | 14 Stück / pcs. |
| 500904025 | für / for DT-01 | 22 Stück / pcs. |
| 500904026 | für / for TL-01 | 24 Stück / pcs. |
| 500904027 | für / for Truck, 2 Achsen - axles | 24 Stück / pcs. |
| 500904028 | für / for Truck, 3 Achsen - axles | 30 Stück / pcs. |
| 500904029 | für / for CC-01 | 18 Stück / pcs. |
| 500904030 | für / for TAMIYA Trailer | 8 Stück / pcs. |
| 500904031 | für / for DT-02 / DT-03 | 14 Stück / pcs. |
| 500904054 | für / for TT-01, TT-02 | 16 Stück / pcs. |
| 500904055 | für / for TT-02 | 16 Stück / pcs. |
| 500904053 | für Scania/MAN 3-Achs / for Scania MAN 3-axle | 32 Stück / pcs. |



Zubehör / Accessories

500908110



Stufenloser Karosseriebohrer bis 14 mm Ø
Continuous body drill with diameters up to 14 mm

500908114



Antennenrohre neon (4 St)
Antenna tube neon (4 pcs.)

500908115



Antennenrohre schwarz (4 St)
Antenna tube black (4 pcs.)

500908078

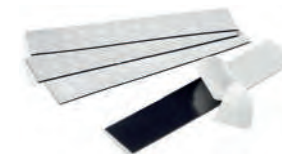

Klebeband doppelseitig schwarz
Two-sided black tape

500013305



Lexan-Schere
Lexan scissor

500405757



1:10 Alu Stoßdämpfer (2) 85mm
1:10 Alu Oil Damper Set (2) 85mm

500405758



1:10 Alu Stoßdämpfer (2) 100mm
1:10 Alu Oil Damper Set (2) 100mm

500405863



1:10 Alu Stoßdämpfer (4) 55mm
1:10 Alu Oil Damper Set (4) 55mm

500405864



1:10 Alu Stoßdämpfer (4) 62mm
1:10 Alu Oil Damper Set (4) 62mm

500405714



1:10 Alu Stoßdämpfer-Set Buggy (4)
1:10 Alu Shock absorbers set Buggy (4)

500405715



1:10 Alu Stoßdämpfer-Set Truggy (4)
1:10 Alu Shock absorbers set Truggy (4)

500405716



1:10 Alu Stoßdämpfer-Set Touring (4)
1:10 Alu Shock absorbers set Touring (4)

500908206



Klettband selbstklebend m. Schaustoff 230x50mm /Adhesive hook & loop tape with foam material

500908133



Transporttasche
Car Bag TAMIYA Fighter

500905100



Startbox 1:8 / 1:10
Startbox 1:8 / 1:10

Zubehör / Accessories

500908162



Corner Marker-Set NEON, Ø 13,5 cm (9 St.)
Corner Marker-Set, Ø 13,5 cm (9 Pcs.)

507401522



Pylonen, Höhe 23,5 cm (4 St.)
Pylonen, Height 23.5 cm (4 pcs.)

500908181



Montagegeständer f.1:10/1:8 (Aluminium)
Car stand 1:10/1:8 (Aluminium)



Professional Tools

- Werkzeugkopf aus gehärtetem Stahl / Tool head made from hardened steel
- leichter und griffiger Werkzeugschaft / Light-weight, easy grip tool shaft

| CARSON Tools | | |
|--------------|-----------|--|
| | 500908125 | Sechskant-Steckschlüssel 1,5 mm / hexagon socket wrench 1,5 mm |
| | 500908126 | Sechskant-Steckschlüssel 2,0 mm / hexagon socket wrench 2,0 mm |
| | 500908127 | Sechskant-Steckschlüssel 2,5 mm / hexagon socket wrench 2,5 mm |

Paint Killer



PATENTIERT
weltweit exclusive by
CARSON-MODEL SPORT

500908141
Lackentferner Sprühdose 200ml / paintkiller Spraycan 200ml

Dieser Lackentferner entfernt alle X- und XF-Lacke, AS- und TS-Sprühfarben, PC- und PS-Lexanfarben sowie viele andere Lacksysteme bis hin zu 2-K Lacken. Der Hammer aber ist, dass diese Lacke entfernt werden, ohne das Trägermaterial wie Plastik, Lexan, Resine, Metall oder Modellverglasungen anzugreifen.

This paint killer removes X and XF paint, AS and TS spray paint, PC and PS lexan paint and many other paint system up to 2-component paint. What's so great about it: Paint is removed without damaging the base material such as plastic, lean, resine, metal or model glazing.



PATENTIERT
weltweit exclusive by
CARSON-MODEL SPORT



500908113
Lackentferner Flasche / paintkiller bottle

Dieser Lackentferner entfernt alle X- und XF-Lacke, AS- und TS-Sprühfarben, PC- und PS-Lexanfarben sowie viele andere Lacksysteme bis hin zu 2-K Lacken. Der Hammer aber ist, dass diese Lacke entfernt werden, ohne das Trägermaterial wie Plastik, Lexan, Resine, Metall oder Modellverglasungen anzugreifen.

This paint killer removes X and XF paint, AS and TS spray paint, PC and PS lexan paint and many other paint system up to 2-component paint. What's so great about it: Paint is removed without damaging the base material such as plastic, lean, resine, metal or model glazing.





500908124
Teamtasche / Team bag
„TAMIYA-Design“

Stylische RC-Car Transporttasche im TAMIYA-Design. Zwei stabile Kunststoff-Schubladen sorgen für die Sicherheit von Modellen und Equipment, durch die riesige Frontklappe entnehmbar. Außenmaße: LxBxH ca. 52/34/35 cm (Modelle und Zubehör separat erhältlich)

Cool rc-car team bag featuring the Tamiya-design. Two boxes take care of models and equipment. Can be replaced through the huge front hood. Size: LxWxH app. 53/34/35 cm (Models and accessory not included)



500908136
Schraubunterlage / Car Matt
TAMIYA

Die Schraubunterlage in TAMIYA World Champion Team-Design. Maße B/H: ca. 98/60 cm
The Car matt in TAMIYA World Champion Team-Design. Size W/H: app. 98/60 cm



500908133
Transporttasche / Car Bag
TAMIYA Fighter

Die Fightertasche in TAMIYA World Champion Team-Design. Maße B/H/T: ca. 64/29/36 cm
The Car bag in TAMIYA World Champion Team-Design. Size W/H/D: app. 64/29/36 cm



500908178
Transporttasche / Car Bag
XL TAMIYA Version

Die Fightertasche in TAMIYA World Champion Team-Design. Maße B/H/T: ca. 64/29/36 cm
The Car bag in TAMIYA World Champion Team-Design. Size W/H/D: app. 64/29/36 cm

1:10 Karosserien On-Road / 1:10 Bodies On-Road

Fan Stuff / Fan Stuff

500013730



Audi Quattro Gr. 4 Karosserie klar
Audi Quattro Gr. 4 Body clear

500800070



Trabant 601 S Karosserie mit Dekor
Trabant 601 S Body with decal

500800051



VW Scirocco Karosserie blau mit Dekor
VW Scirocco Body blue with decal

500909064



Kugelschreiber CARSON
Ball pen CARSON

500800054



VW Scirocco Karosserie weiß mit Dekor
VW Scirocco Body white with decal

500800027



Porsche GT-3 RS Karosserie schwarz mit Dekor (ohne Bohrungen) / Porsche GT-3 RS Body black with decals (without holes)

500800059



Porsche GT-3 RS Karosserie weiß mit Dekor
Porsche GT-3 RS Body white with decal



Karosseriekammern Je 10 Stück / body braces á 10 pieces

| | |
|-----------|---------------------------|
| 500908058 | 15 mm 1:12 / 1:14 Modelle |
| 500908059 | 20 mm 1:10 Modelle |
| 500908060 | 24 mm 1:10 Modelle |
| 500908062 | 27 mm 1:8 Modelle |
| 500908063 | 34 mm 1:8 / 1:5 Modelle |



Unser Service für Sie / Our service for you

Für weitere Ersatzteile wenden Sie sich bitte an unseren Service: service@tamiya-carson.de!

For further spare parts please contact our service: service@tamiya-carson.de!





Unser Service für Sie.

Bilddaten, Videos, Produktbeschreibungen, Kataloge, Logos und vieles mehr. Schnell und einfach. In höchster Qualität. Mit nur einem Klick.

Our Service.

Images, videos, product descriptions, catalogues, logos and much more. Fast and easy. Highest quality. Just one click.



Media Data Base mdb.simbatoy.com

Finden Sie alle unsere Bilddaten und Grafiken auf unserer Mediendatenbank. / Access all our images and graphics on our media data base.



Catalogs catalogs.simba-dickie.com

Blättern Sie durch alle unsere Kataloge auch online auf unserer Webseite, Ihrem Tablet oder Smartphone. / Browse all our catalogues online on our website, your tablet or smartphone.



Website www.carson-modelsport.com

Weitere Informationen finden Sie auf unserer Webseite. Visit our website for additional information.



Videos video.simba-dickie.com

Alle TV-Spots und Filme im Überblick. Einfaches Einbinden aller Videos auf Ihren Online Kanälen. / Get an overview of all our TV-spots and movies. Embed all videos on your online channels.



Logos logos.simba-dickie.com

Alle Logos auf einen Blick, in bester Qualität. An overview of all logos in the highest quality.



Social Media facebook.com/CarsonModelsport

Weitere Informationen finden Sie auf unserer Facebook Seite. Visit our Facebook page for additional information.

SIMBA · DICKIE · GROUP

company.simba-dickie.com

Erfahren Sie mehr über unsere Marken und Historie
Learn more about our brands & history

CARSON

Ihr Partner mit den starken Marken



Art.No. 500990210



TAMIYA-CARSON Modellbau GmbH & Co. KG
Werkstraße 1 . D – 90765 Fürth
www.carson-modelsport.com

SIMBA · DICKIE · GROUP